



Fire Detection & Alarm System

One-stop Fire Solutions





Parent Company Carrier

GST's parent company, Carrier, is an outstanding global provider of healthy, safe sustainable and intelligent building and cold chain solutions with a world-class, diverse workforce, headquartered in Florida, USA. With more than a century of expertise, we drive innovation while putting our customers first, helping protect our planet, and inspiring and empowering our people. Through our performance-driven culture, we are driving shareowner value by growing sales and investing strategically to strengthen our position in the markets we serve.

Our Fire & Security business encompasses a wide range of residential, commercial and industrial systems, including fire and carbon monoxide detection, alarm signaling, incident management, evacuation, monitoring fire, gas and water mist suppression, fire and gas safety solutions and industrial equipment controls. Our security business offers access control and event monitoring, electronic locks, hospitality solutions, mobile apps and credentialing, real estate access solutions, remote access management, video management and video analytics.

Gulf Security Technology Co., Ltd. (GST)

Gulf Security Technology Co., Ltd, GST, is a key player in the Asia fire and security industry and a trusted provider of comprehensive fire system solutions around the world. It is a subsidiary of Carrier (Carrier Global Corporation), an outstanding global provider of healthy, safe sustainable and intelligent building and cold chain solutions with a world-class, diverse workforce.

GST provides a wide range of fire products and customized fire system solutions tailored to the needs of different industries. With a sales infrastructure that covers many countries and regions, and includes a China-wide network of more than 150 sales offices and several logistics centers, GST has become an important part of Carrier's global business.

To satisfy the needs of its global customer base, GST has established extensive R&D facilities in Beijing and Qinhuangdao in northern China. It constantly strives to develop innovative new technologies and products. GST's factory in Qinhuangdao is a large manufacturing base producing intelligent electronic products that incorporate innovative technology. To ensure superior product quality, it has advanced manufacturing and inspection equipment and strong capabilities in quality control and process management.

GST has earned a range of national and international certificates of conformity to standards such as China's CCC, the international UL, the global LPCB, Europe's CE, etc.





Contents

P05	UL Listed Addressable Products
P15	UL Listed Conventional Products
P21	EN54 Addressable Products
P38	EN54 Conventional Products
P46	Explosion Proof Products
P52	Specified Detectors
P56	Gas Release Control Products
P59	Tools and Accessories
P63	Software
P65	System Diagram
P70	Emergency Voice Evacuation

UL Listed Addressable Products

Leading innovative technology
Safeguarding lives and properties

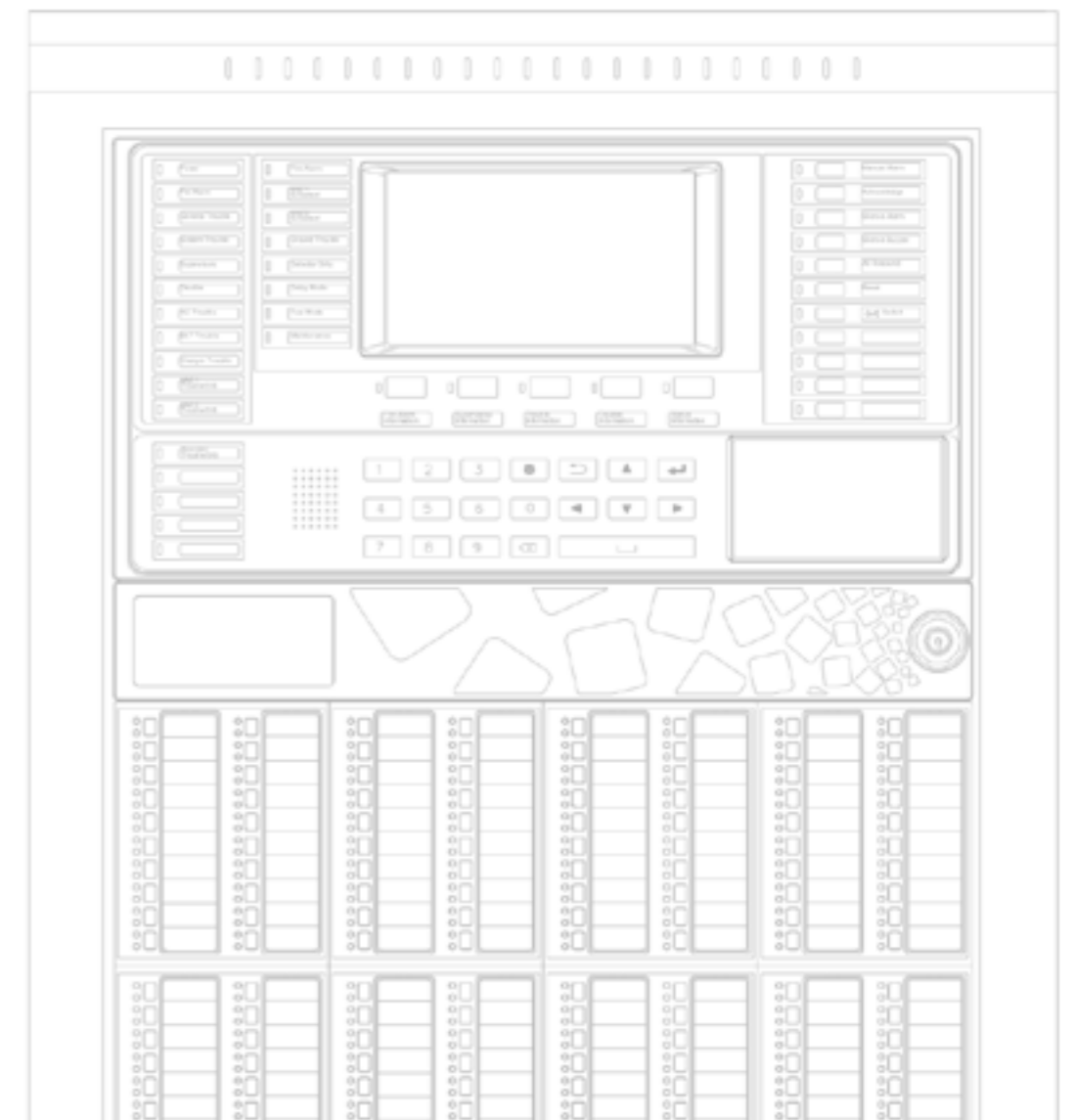

GST-IFP4M (Grey/Red)
GST-IFP4M-S (Small/Grey)
GST-IFP4M-S-R (Small/Red)



Intelligent Fire Alarm Control Panel

Complies with UL864 10th Edition standards. All circuit boards are installed in a metal cabinet optional in red or grey color, providing a complete fire control system for most applications. Modularized structure allows the panel to meet different requirements by adjusting the configuration. Very easy for installation, operation and maintenance.

Features

- 7-inch touch screen
- Wide range power supply 100-240V 50/60Hz
- Support 1-6 loops in Class A style (additional battery box is required for 5 or 6 loops application)
- 242 addressable devices per loop mixing various types of devices, max. 1452 addresses
- History records of 100,000 events
- 2 Power Limited Class B Notification Appliance Circuits (NAC), total load max.2.5A/24VDC. The 2nd NAC can be set as AUX.
- "Walk test", silent or audible
- Positive Alarm Sequence (PAS) per point
- Report device type mismatch and duplicated address
- CAN/Fiber Networking, Panel grouping
- Redundancy CPU
- Option connecting with BMS via optional Modbus Card or built-in BACnet (License for order optionally)
- Multi languages: Standard English language and other regional languages
- Cabinet color options: Grey, Red
- Cabinet size option:
 Regular (GST-IFP4M): 815mm*490mm*144mm; with Zone Display Panel option
 Small(GST-IFP4M-S): 560mm*490mm*144mm; without Zone Display Panel option

UL is a registered trademark owned by UL LLC.



LC-401
Single Loop Card



P-9966A
CAN Class A Network Card



LC-402
Dual Loop Card



P-9956-ModBus
ModBus Card for 3rd party interfacing



P-9983
Fibre Network Card



P-9981
Zone Display Panel (Bicolor)



P-9982
Zone Display and Control Panel (Bicolor)



P-9981F
Zone Display Panel (Fixed)



P-9982F
Zone Display and Control Panel (Fixed)



MP-401
Redundancy CPU Card



PR-400B
Thermal Printer (RS232)

GST-M200

Intelligent Fire Alarm Control Panel

Adopts GST digital loop protocol for an intelligent fire alarm system. 1/2 loops, wall-mounted, suitable for small to medium-sized projects.



Features

- Single loop of 240 address
- Optional L200 to expand the 2nd loop/extra 242 addresses
- 100VAC to 230VAC, 50/60Hz
- 2 Style Y Notification Appliance Circuits (NAC)
- 3 fixed relay outputs for fire/fault/supervisory
- Optional USB printer interface
- Optional graphic monitor station connection
- Walk Test function
- Positive Alarm Sequence (PAS) per point
- Advanced user friendly programming software including 'Fuzzy Logic'
- Programmable by keypad or by PC through P-9930 communication card

LC200

Loop Card



P-9930

RS232 Communication Card



P-M9930Modbus

RS232 ModBus Communication Card



GST-MNA2C(CAN) GST-MNA2F(Fibre)

Network Annunciator

Complies with UL864 10th Edition standards. All circuit boards are installed in a metal cabinet, optional in red or grey color, providing a complete fire control system for most applications. Modularized structure allows the panel possible to meet different requirements by adjusting the configuration. Very easy for installation, operation and maintenance.



Features

- Receive message and send command (Reset, Silence, ACK, etc.) through network
- LCD display unit of 800 x 480, 7.0" color TFT LCD
- Capacitive touch screen
- History file 100,000 events capacity
- Password and key-protected non-volatile memory
- User programmable password
- Field-programmable or by pc with GST-IFPx-Def Defining Tool
- Network interface:
GST-MNA2C: CAN, Class A
GST-MNA2F: Fiber-Optic, Class A
- Cabinet color options: Grey, Red

DI-M910X Series Detectors

Adopt the latest digital loop protocol compatible with GST UL listed intelligent fire alarm control panels. With digital communication protocol, the detectors can quickly raise an alarm signal with full features within seconds, suitable for hotels, restaurants, office buildings, schools, banks, warehouses, libraries, computer rooms, switch rooms, etc.



DI-M9101

Intelligent Combination Heat Photoelectric Smoke Detector

- Electronic addressed, easy to rewrite on site
- Drift compensation, strong environmental adaptability, anti-pollution ability
- Fixed-temperature fire alarm via semi-conductor heat sensor that analyzes temperature status
- Fire LED allows 360° viewing
- Option to switch off polling LED avoiding light interference
- 2-level programmable sensitivities
- Reed switch test
- Auto-diagnostic for sensor fault and optical chamber dusty
- Removable innovative sensing chamber, easy for maintenance
- Built in alarm output circuit, each detector can connect to a remote indicator C-9314P and BP-9314



DI-M9102

Intelligent Photoelectric Smoke Detector

- Electronic addressed, easy to rewrite on site
- Drift compensation, strong environmental adaptability, anti-pollution ability
- Fire LED allows 360° viewing
- Option to switch off polling LED avoiding light interference
- Reed switch test
- Auto-diagnostic for sensor fault and optical chamber dusty
- Removable innovative sensing chamber, easy for maintenance
- Built in alarm output circuit, each detector can connect to a remote indicator C-9314P and BP-9314



DI-M9103

Intelligent Rate-of-Rise and Fixed-Temperature Heat Detector

- Electronic addressed, easy to rewrite on site
- Semiconductor heat sensor analyzing temperature status
- FT or FT/RoR heat detection mode programmable
- High sensitivity temperature sensor, fast response
- Highly reliable sensor, long life, high reliability
- Reed switch test
- Auto-diagnostic capability
- Fire LED allows 360° viewing
- Option to switch off polling LED avoiding light interference
- Built in alarm output circuit, each detector can connect to a remote indicator C-9314P and BP-9314



DB-M01

Common Detector Base
Waterproof design



C-9314P

Remote Indicator

BP-9314

Back Plate



DI-M9300

Digital Single Input Module

DI-M9300 is used to connect the equipment which provides normally open or normally closed dry contact output signals, such as Flow Switch, Zonal Valve, Fire Pump, etc. Once the module detects the action of the equipment, a signal will be sent to the fire alarm control panel.

- Miniaturized design, suitable for centralized installation
- Din-Rail mount or Surface mount
- Monitor normally open or normally closed dry contact input signal
- Input port monitored with 4.7K EOLR
- Electronic addressed, easy to rewrite on site
- Loop powered, low power consumption



DI-M9319

Digital Zone Monitor Module

DI-M9319 is designed to connect conventional detectors into an addressable system. When any device reports fire signal, the module will transmit the signal to the fire alarm control panel which generates a fire alarm and displays the address of the module

- Miniaturized design, suitable for centralized installation
- Din-Rail mount or surface mount
- Input port cable monitoring with 4.7K EOLR
- Maximum 30 conventional detectors or manual call points can be connected to each module
- Provides a FORM-C dry contact output with the capacity of 2A @ 30VDC
- Normally-open or Normally-closed output automatically follows Input port to change state
- Two indicators for fire and fault
- Electronic addressed, easy to rewrite on site
- Powered by loop and external 24V, Monitoring power supply



DI-M9301

Digital Single Input and Output Module

DI-M9301 is used to connect equipment which needs to be controlled by fire alarm control panel, such as elevator, fire door, etc. It also can receive the action signal from the controlled equipment and send it to the fire alarm control panel.

- Miniaturized design, suitable for centralized installation
- Din-Rail mount or surface mount
- Normally open dry contact output with cable monitoring function
- Monitor normally open or normally closed contact input signal
- Input port monitored with 4.7K EOLR
- Input port co-operates with output or works individually
- Electronic addressed, easy to rewrite on site
- Occupy one or two loop addresses
- Loop powered, low power consumption



DI-M9305

Digital Single Riser Output Module

DI-M9305 is designed to connect conventional VADs or notification devices and switch on/off the supply to end devices.

- Miniaturized design, suitable for centralized installation
- Din-Rail mount or surface mount
- Relay capacity 2A@30VDC or maximum 60W 70V/100V audio speakers
- Supervised input and output port cable
- Double-contact relay switching 2 lines together
- Electronic addressed, easy to rewrite on site
- Powered by loop and external power input
- Low power consumption



DC-M9503

Loop Isolator Module

DC-M9503 is Din-Rail module type isolator to be installed and terminated individually, protecting the loop by isolating the trouble part.

- LED status indicator
- Support Class A and Class B loop connection
- Maximum 128 isolators can be connected to each loop
- Maximum 50 devices between two isolators
- Automatically restore once the fault has been cleared
- Loop powered, lower power consumption

GST-MBX22 GST-MBX29

Module Box

Optional accessories for both UL and LPCB D series Din-Rail modules for centralized installation, include mounting strip and cable trunking.

GST-MBX22: 6 ~ 10 pieces modules GST-MBX29: 12 ~ 20 pieces modules

D-93TC1(1U) D-93TC2(2U)

Din-rail Module Transparent Cover

D-93TC1: Suitable for DC-9503E, DI-9300E, DC-M9503 and DI-M9300

D-93TC2: Suitable for DI-9301E, DI-9305E, DI-9319E, DI-M9301, DI-M9305 and DI-M9319

UL Listed Conventional Products



DI-M9204

Digital Manual Call Point

DI-M9204 adopts the latest digital loop protocol, semi-flush mount type. A back box is supplied for surface mounting.

- Re-settable (non-breaking glass) via special key
- Dual activation indication
- Electronically addressed
- Friendly installation and test
- Wiring before termination



DI-M9402

Intelligent Sounder Base

DI-M9402 are compatible with GST-IFPXM series fire alarm control panels, to provide panel level synchronized audio output after activated.

- Electronically addressed
- Plugged together with DI-M910x series detectors
- Sound Pressure Level ≥ 85 dB
- Sound Frequency 3100Hz
- Loop powered, low power consumption

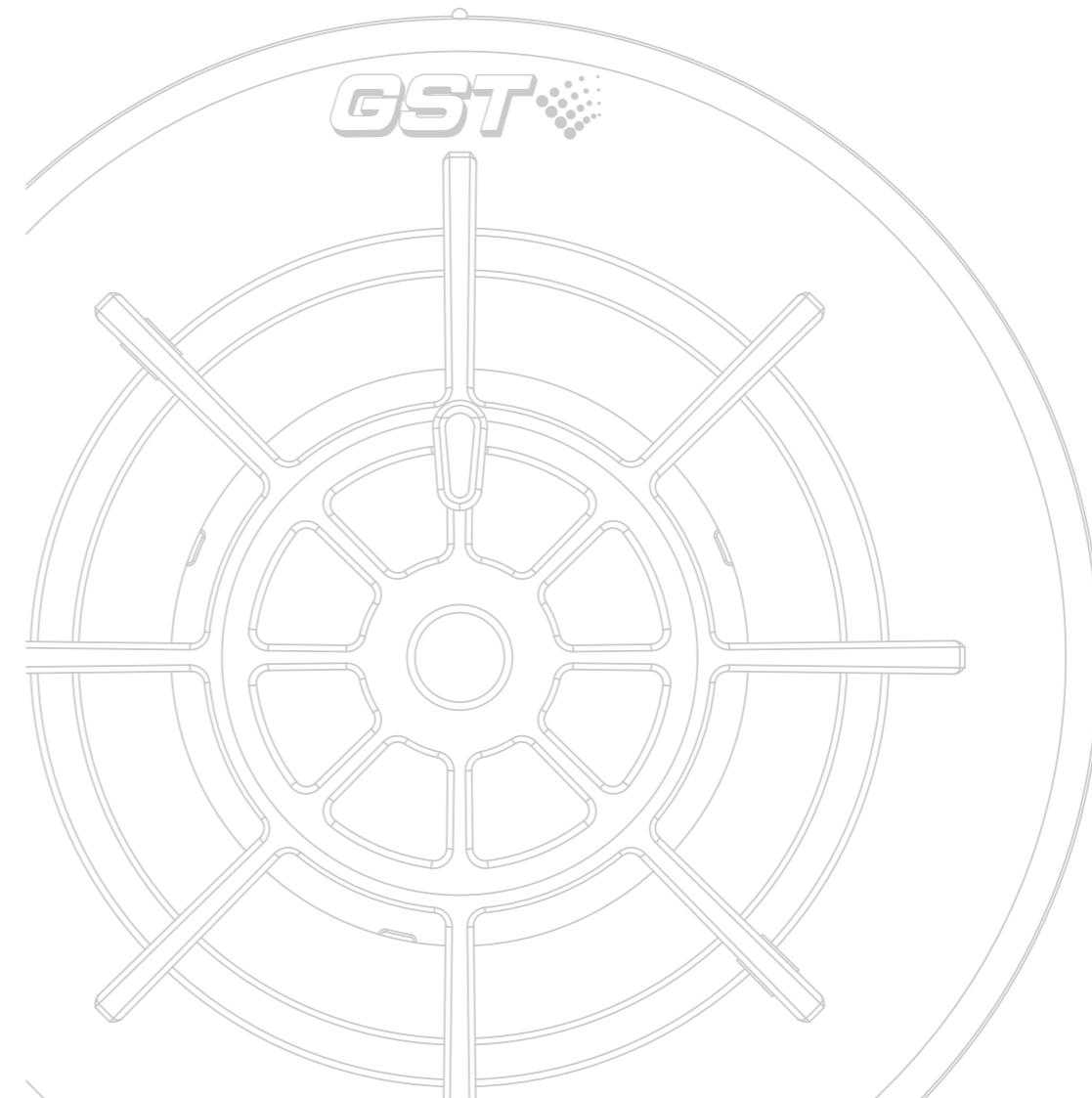

DC-M910X Series Detectors

2 wire type with low power consumption, alarm equivalent resistance 680Ω, suitable to build a fire alarm system together with UL listed conventional panels or addressable interface modules for hotel, restaurant, office building, school, bank, warehouse, library, computer room, switch room etc.

- Strong environmental adaptability due to drift compensation
- Auto-diagnostic
- Reed switch test
- Fire LED allows 360° viewing
- Possible to switch off polling LED, avoid light interference
- Built in alarm output circuit, each detector can connect to a remote indicator C-9314P and BP-9314



DC-M9101

Conventional Combination Heat Photoelectric Smoke Detector

- Smoke and heat sensor are integrated in mechanism and circuitry structure
- 2 smoke sensitivity levels can be set
- Heat detection is based on FT



DC-M9102

Conventional Photoelectric Smoke Detector

- Light scattering technology with high performance chamber
- Suitable for detecting slow burning or smoldering fires



DC-M9103

Conventional Rate of Rise and Fixed Temperature Heat Detector

- Semiconductor heat sensor
- Dual Rate-of-Rise and Fixed-Temperature
- Rate-of-Rise detection can be disabled by programmer



DB-M01

Common Detector Base
Waterproof Design



C-9314P

Remote Indicator

BP-9314

Back Plate



**DC-M9413R(Red)
DC-M9413W(White)**

Wall Mount Sounder Strobe

- Configure dB output, sounder signal, and strobe signal output as per environment
- 15 to 110 candela output, selectable user-friendly switch on the side of the device
- The candela output switch remains clearly visible after final installation, staying locked in place to prevent unauthorized tampering.
- Synchronized operation requires connection to a NAC output, set to Synch Mode or to a DC-M9410 Signal Synchronization Module
- Comply with UL464, UL1638, UL1971



**DC-M9415R(Red)
DC-M9415W (White)**

Wall Mount Strobe

- Field-configurable switch for desired candela output.
- Field-configurable jumper for the strobe signal output.
- Synchronized operation requires connection to a NAC output, set to Synch Mode or to a DC-M9410 Signal Synchronization Module
- Comply with UL1638, UL1971



**DC-M9414R(Red)
DC-M9414W(White)**

Wall Mount Sounder

- Configure dB output as per environment.
- Temporal or steady sounder output selectable
- Synchronized operation requires connection to a NAC output, set to Synch Mode or to a DC-M9410 Signal Synchronization Module
- Comply with UL 464



**DC-M9416R(Red)
DC-M9416W(White)**

Ceiling Mount Sounder Strobe

- Field-configurable for desired dB output, temporal or steady sound output and strobe signal output
- Field-configurable switch for desired candela output
- Synchronized operation requires to connect it to a NAC output set of Synch Mode, or to a DC-M9410 Signal Synchronization Module
- Comply with UL464, UL1638, UL1971



DC-M9410

Signal Synchronization Module



DC-M9204

Innovation Manual Call Point

DC-M9204 can be used with a compatible conventional fire alarm control panel or addressable modules to send out alarm signal by pressing the glass if there is a fire.

- Re-settable (non-breaking glass) via special key
- Dual activation indication
- Friendly installation and test
- Semi-flush mount, with a back box for surface mount



DC-M9402

Conventional Sounder Base

DC-M9402 is compatible with GST-IFPXM series fire alarm control panels, driven by panel NAC output or DI-M9305 single riser module output providing synchronized audio output after activated.

- Both DC-M910x and DI-M910x compatible
- Sound Pressure Level ≥ 85dB
- Sound Frequency 3100Hz

EN54 Addressable Products

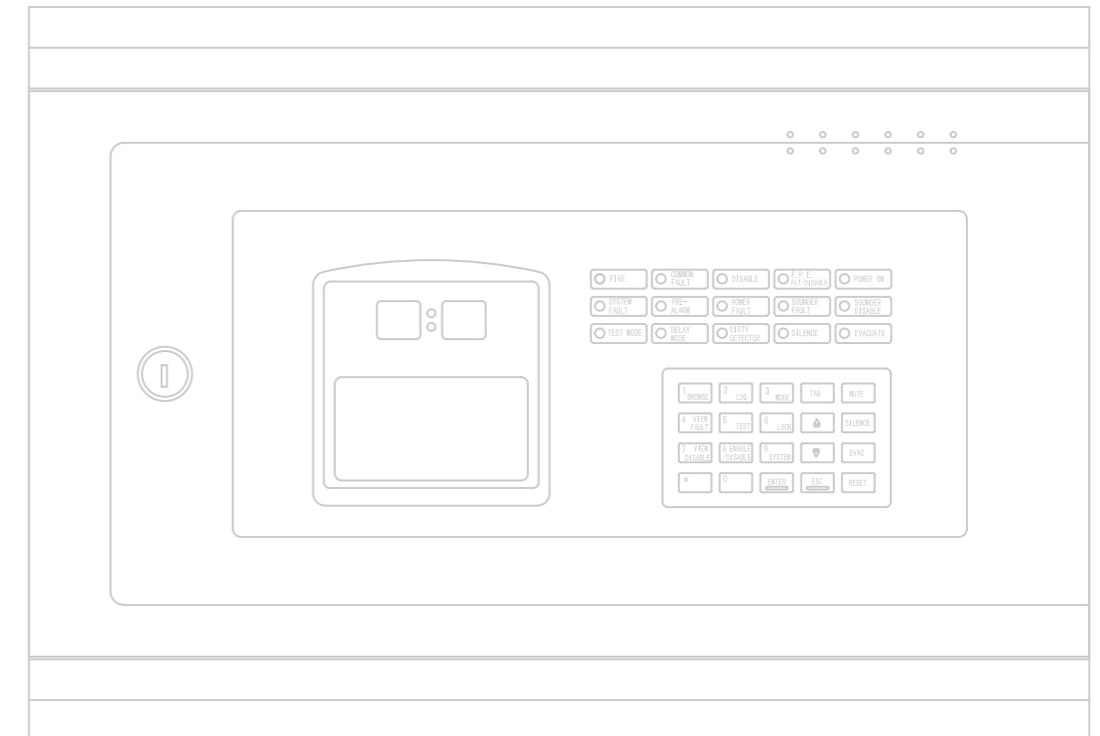

GST-IFP8

Intelligent Fire Alarm Control Panel



GST-IFP8 is a modularized, multi-loops fire alarm control panel. It is capable to expand to 8 loops, network up to 100 panels via class A and 240 panels via class B, perfect for small, medium and large projects.

- 15*40 LCD display
- Max. 999 zones, up to 140 with own alarm, fault/disable LEDs
- Non-Volatile Memory
- 3 alarm outputs, sounder/F.P.E/Alarm Routing
- Built-in sounder output 1A/24V
- Detector dirty report
- PAS and acknowledge function
- Multiple interface options: RS232, RS485, TCP/IP, CAN
- Built in printer
- Non-volatile memory ensures data is not lost even if power supply is accidentally removed

Models

- | | |
|---------------|--------------|
| • GST-IFP8 | • English |
| • GST-IFP8-PT | • Portuguese |
| • GST-IFP8-HU | • Hungarian |
| • GST-IFP8-FR | • French |
| • GST-IFP8-IT | • Italian |
| • GST-IFP8-SP | • Spanish |
| • GST-IFP8-TK | • Turkish |

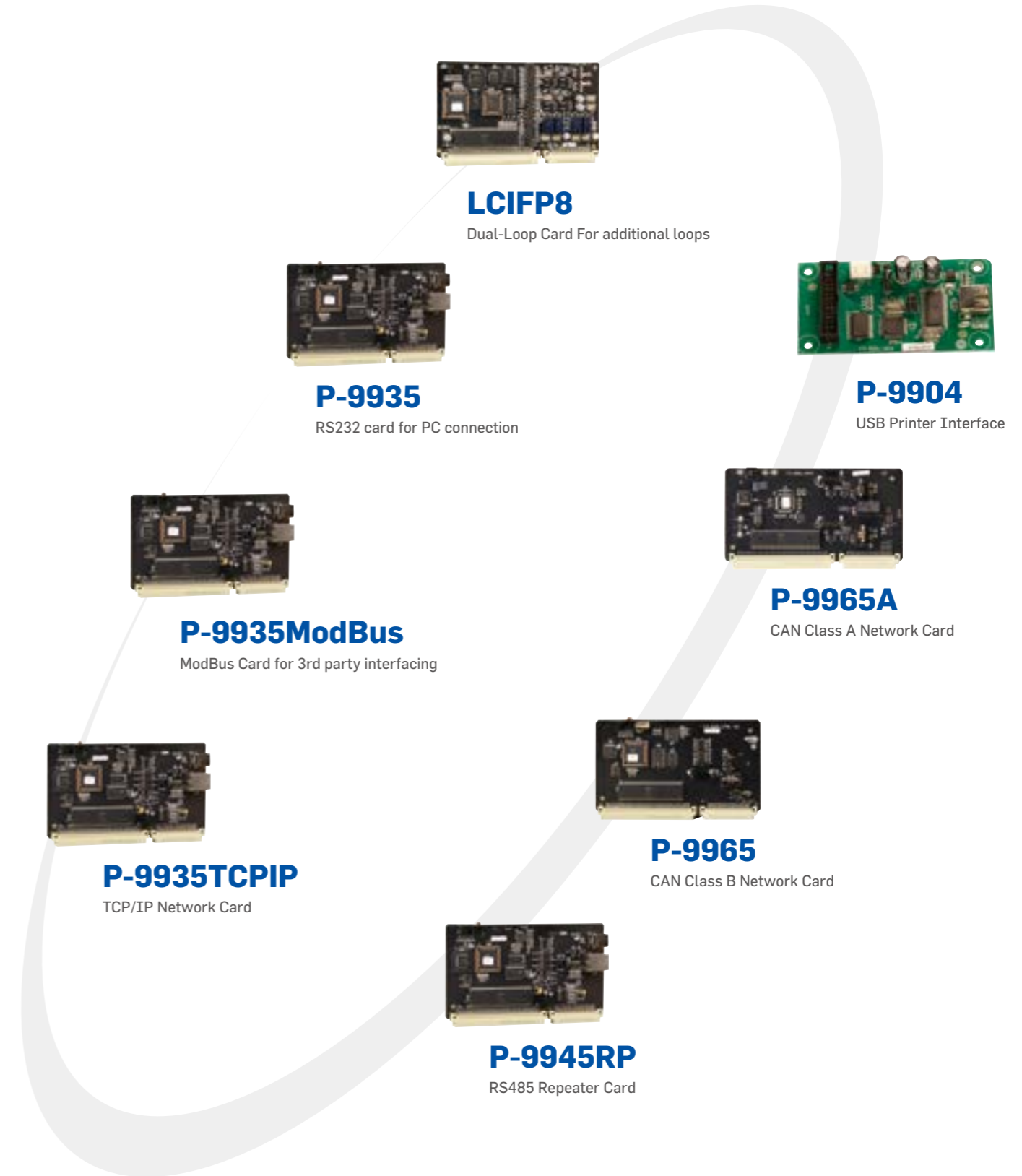

LCIFP8

Dual-Loop Card For additional loops



P-9935

RS232 card for PC connection



P-9904

USB Printer Interface



P-9935ModBus

ModBus Card for 3rd party interfacing



P-9965A

CAN Class A Network Card



P-9935TCPIP

TCP/IP Network Card



P-9965

CAN Class B Network Card



P-9945RP

RS485 Repeater Card

GST200N

Intelligent Fire Alarm Control Panel



GST200N Series includes GST200N-1 for 1 loop and GST200N-2 for 2 loops, capable to network up to 100 panels via class A and 240 panels via class B. It is designed for small buildings like office, restaurant, store, shop, etc., provide simple installation, operation, and easy maintenance.

- 8 lines LCD display
- Wide range power supply unit: 100-240VAC 50/60Hz
- Non-Volatile Memory
- 30 zones with own alarm, fault/disable LEDs
- Manual buttons for each zone, to activate/silence sounder strobes
- Built-in sounder output, F.P.E output, alarm output
- Configurable N/O, N/C or 0.5A/24V
- Detector dirty report
- PAS and acknowledge function
- Walk test
- Built in RS485 repeater output (max. 10 repeaters)
- Modbus interface for BMS connection

Models

- | | |
|--------------|---------------------------|
| • GST200N-1 | • Single loop, English |
| • GST200N-2 | • Dual loops, English |
| • GST200N-HU | • Single loop, Hungarian |
| • GST200N-PT | • Single loop, Portuguese |
| • GST200N-SP | • Single loop, Spanish |
| • GST200N-IT | • Single loop, Italian |
| • GST200N-FR | • Single loop, French |
| • GST200N-TK | • Single loop, Turkish |
| • GST200N-RO | • Single loop, Romanian |

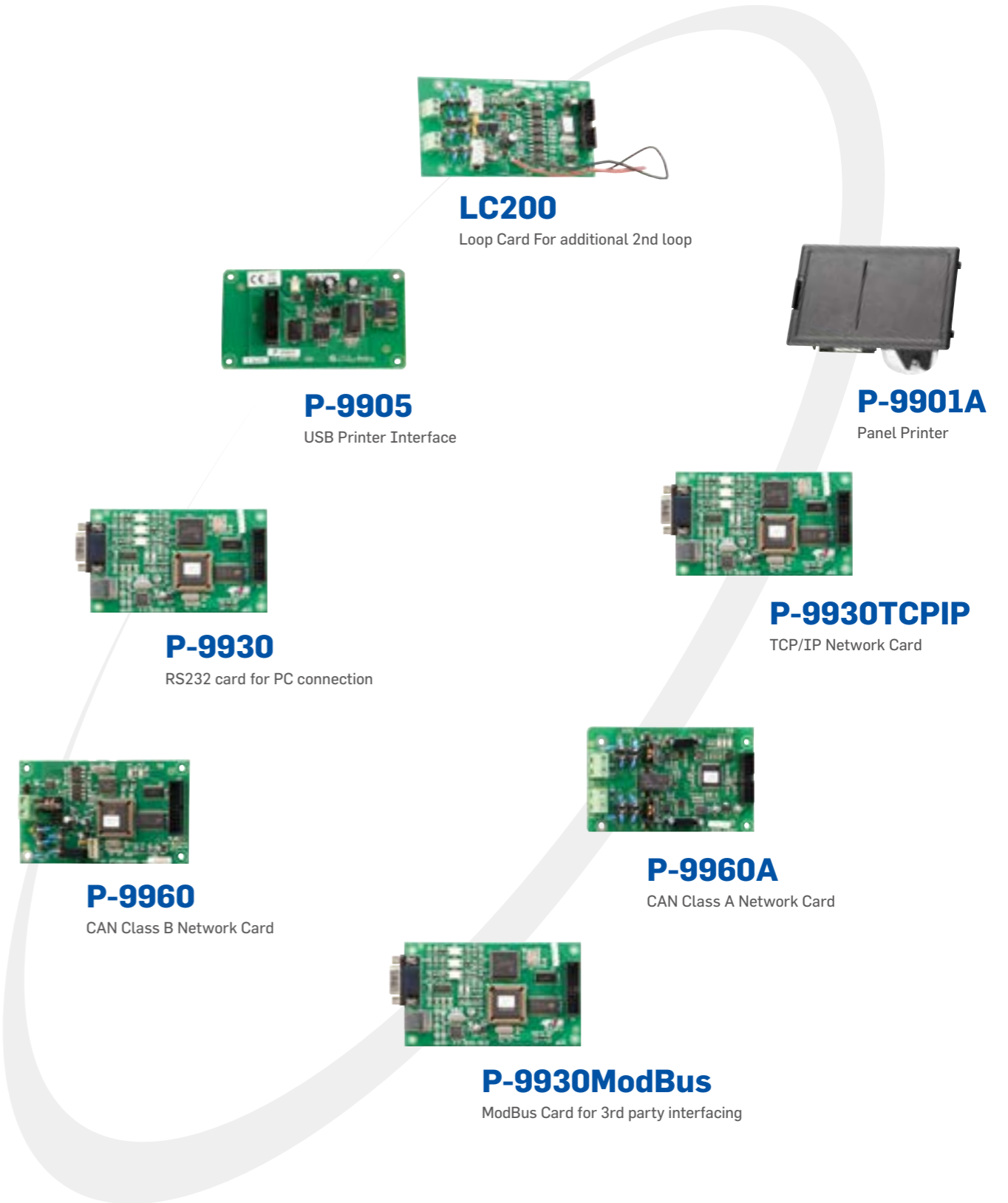

LC200
Loop Card For additional 2nd loop



P-9905
USB Printer Interface



P-9901A
Panel Printer



P-9930
RS232 card for PC connection



P-9930TCPIP
TCP/IP Network Card



P-9960
CAN Class B Network Card



P-9960A
CAN Class A Network Card



P-9930ModBus
ModBus Card for 3rd party interfacing

GST100

Intelligent Fire Alarm Control Panel



Minimized single loop addressable fire panel, designed in accordance with EN54-2 standard, to achieve simple installation, operation and maintenance, which make it ideal for smaller systems.

- Maximum 8 detection zones, each with independent fire LED, fault/disable LED and zone label
- Class A loop, maximum capacity of 128 addressable devices
- 122x32 lattice LCD assisting the LED indicators to display important information
- Non-volatile memory ensuring system data not lost on shutdown of power
- 3 relay outputs available which are SOUNDER OUTPUT (R+ and R-), ALARM OUTPUT and FAULT OUTPUT

P-9943

RS485 Communication Card

For connecting repeater panel or network



GST-NRP00

Network Repeater Panel



GST-NRP00 Network Repeater Panel is based on GST network technology, providing remote control and indication of the fire alarm system.

- Provide remote display and control of system
- Password protected access levels
- 8X18 characters LCD screen
- 15 LEDs to display important information
- Functional control of network panels
- Network-wide operation: Acknowledge, Silence, Reset
- Flush-mount or surface-mount structure
- Meet network protocol by selecting suitable network network card



P-9960

CAN Class B Network Card



P-9960A

CAN Class A Network Card



GST852RP

LCD Repeater Panel



A remote indication unit through LCD screen for GST addressable system. In case of fire, it will display the fire type, time and location details together with sound for local notification.

- Large LCD display with backlight
- Mute and lamp test
- Electrically addressing
- RS485 network

GST8903

Intelligent Graphic Repeater Panel



A remote indication through graphic layout for the GST addressable system, also known as the MIMIC panel. In case of fire or fault, a message will be displayed indicating the specific position within the layout drawing, providing a clear view of the exact location.

- Up to 100 LED indication points
- Local buzzer alarm and mute
- Customized graphical layout to project requirement
- Programmable to display zones or individual device
- Programmable to indicate Fire, Action and Fault conditions
- RS485 network
- A3, A2, A1 sizes

DI-910XE Series Detectors

Adopt the latest digital loop protocol, compatible with GST LPCB listed intelligent fire alarm control panels. With digital communication, the detectors can raise fast alarm signal within seconds, with full features, suitable for hotel, restaurant, office building, school, bank, warehouse, library, computer room, switch room etc.

**DI-9101E
DI-9101E-B**

Intelligent Combination Heat Photoelectric Smoke Detector

- Electronic addressed, easy to rewrite on site
- Drift compensation, strong environmental adaptability, anti-pollution ability
- Dual FT& RoR fire alarm by semiconductor heat sensor analyzing temperature status
- Heat Detection: Class A2R
- Fire LED allows 360° viewing
- Option to switch off polling LED avoid annoying
- 2 levels sensitivities programmable
- Reed switch test, Self-diagnostic for sensor fault and optical chamber dust
- Easy for maintenance.
- Built in alarm output circuit, each detector can connect to a remote indicator C-9314P
- LPCB approved at EN 54-7 and EN 54-5
- White and Black color options



DI-9102E

Intelligent Photoelectric Smoke Detector

- Electronic addressed, easy to rewrite on site
- Drift compensation, strong environmental adaptability, anti-pollution ability
- Fire LED allows 360° viewing
- Option to switch off polling LED avoid annoying
- 2 levels sensitivities programmable
- Reed switch test for easy test
- Self-diagnostic capability
- Removable innovative sensing chamber, easy for maintenance.
- Built in alarm output circuit, each detector can connect to a remote indicator C-9314P
- LPCB approved at EN 54-7





DI-9103E

Intelligent Rate of Rise and Fixed Temperature Heat Detector

- Electronic addressed, easy to rewrite on site
- Dual FT and RR fire alarm by semiconductor heat sensor analyzing temperature status
- A1R, A2S, BS, 3 detection class programmable
- High sensitivity temperature sensor, fast response
- Highly reliable sensor, long life, high reliability
- Reed switch test for easy test
- Self-diagnostic capability
- Fire LED allows 360° viewing
- Option to switch off polling LED avoid light interference
- Built in alarm output circuit, each detector can connect to a remote indicator C-9314P
- LPCB approved at EN 54-5



DB-01 DB-01B

Common Detector Base

Waterproof weep hole design



DC-9504E

Base Mount Isolator

DC-9504E is a base type isolator, to use with DI series detectors replacing DB-01, providing detector based trouble isolation



C-9314P

Remote Indicator



DI-9105E

Intelligent Reflective Beam Detector

Built-in microprocessor to reach high sensitivity application, suitable to historical buildings, warehouses, large storages, shopping malls, leisure centers, exhibition halls, hotel lobbies, printing houses, clothing factories, museums, and prisons.

- Loop powered
- Electronic addressed, easy to rewrite on site
- Wide operating voltage range, large monitoring areas
- Built-in laser pointer and digital tube display facilitate the alignment between detector and the reflector, and greatly improve the on-site commissioning efficiency
- Combination of the emitting and receiving parts makes mounting easy and optical pathway accurate
- Intelligent self-adjustment, drift compensation of ambient data, such as dust accumulation, positional excursion, and ageing transmitter
- Intelligent auto-judgment about fire alarm and fault
- Self-diagnostic function can monitor the internal fault
- 4 sensitivity levels can be set in field to suit different applications
- Ingress protection is up to IP66 through glue-seal treatment for special environment applications
- Attractive appearance



RF-9105R

Reflector



DI-9300E

Digital Single Input Module

DI-9300E is used to connect the equipment which provides normally open or normally closed dry contact output signal, such as Flow Switch, Zonal Valve, Fire Pump etc. Once the module detects the action of the equipment, it will send the signal to the fire alarm control panel.

- Miniaturized design, suitable for centralized installation
- Din-Rail mount or surface mount
- Monitor normally open or normally closed dry contact input signal
- Input port monitored with 4.7K EOLR
- Electronic addressed, easy to rewrite on site
- Loop powered, low power consumption



DI-9301E

Digital Single Input and Output Module

DI-9301E is used to connect the equipment which needs to be controlled by fire alarm control panel, such as elevator, fire door etc. It also can receive the action signal from the controlled equipment and send it to the fire alarm control panel.

- Miniaturized design, suitable for centralized installation
- Din- Rail mount or surface mount
- Normally open dry contact output with cable monitoring function
- Input port monitors either normally open or normally closed dry contact
- Input port co-operates with output or works individually
- Input port monitored with 4.7K EOLR
- Electronic addressed with 1-2 address options, easy to rewrite on site
- Loop powered, low power consumption



DI-9302E

Digital High Voltage Relay Module

DI-9302E provides output capacity 220VAC/5A, suitable to connect the high voltage equipment being controlled by the fire alarm control panel.

- Miniaturized design, suitable for centralized installation
- Din-rail mount or surface mount
- Input port monitors either normally open or normally closed dry contact.
- Special onboard relay test button to test relay action instead of being operated from FACP
- High voltage terminals are covered by transparent cover protecting from electric shock
- Input port can be programmed "self-answering"
- Electronic addressed with 1-2 address options, easy to rewrite on site
- Using GST-IFPxE series Panel, invert mode or normal mode can be set
- Loop powered, low power consumption



DI-9305E

Digital Single Riser Output Module

DI-9305E is designed to connect conventional VADs or notification devices, to switch on and off the supply to end devices.

- Miniaturized design, suitable for centralized installation
- Din-Rail mount or surface mount
- Relay capacity 2A@30VDC or maximum 60W 70V/100V audio speakers
- Supervised Input and Output port cables
- Double-contact relay switching 2 lines together
- Electronic addressed, easy to rewrite on site
- Powered by loop and external power input
- Low power consumption



DI-9319E

Digital Zone Monitor Module

DI-9319E is designed to connect conventional detectors into an addressable system. When any device reports a fire signal, the module will transmit the signal to the fire alarm control panel.

- Din-rail mount or surface mount
- Input port cable monitoring with 4.7K EOLR
- Maximum 30 conventional detectors or manual call points can be connected to each module
- Provides a FORM-C dry contact output with the capacity of 2A @ 30VDC
- Normally-open or normally-closed output automatically follows Input port to change state
- Two indicators for fire and fault
- Electronic addressed, easy to rewrite on site
- Powered by loop and external 24V, monitoring power supply



DC-9503E

Loop Isolator

DC-9503E is Din-rail module type isolator to be installed and terminated individually, preventing the whole loop from the troubled part.

- Isolates faulty part of the loop in the event of a short circuit
- Automatically restores once the fault has been cleared
- LED status indicator
- Support Class A and Class B loop connection
- Maximum 128 isolators can be connected to each loop
- Maximum 50 devices between two isolators
- Loop powered, lower power consumption

DI-9309

Addressable Multi-Channel Interface

DI-9309 provides an integrated solution for application of multi-input signals, saving mounting space and installation cost.

- Max. 16 channels of independent inputs. The quantity can be set by jumpers as required
- Two channels of independent dry contact outputs
- 3-18 consecutive addresses, changing with selected channel quantity
- Monitored power supply
- Monitored cable for open circuit and short circuit



I-9401N

Addressable Sounder Strobe

- Electronic addressed, easy to rewrite on site
- Red Plexiglas lens, hi-light red, striking, long-life
- Sound level over 80dB
- Plug in structure for easy installation



I-9403/I-9404

Intelligent Sounder Strobe/ Sounder

- Electronic addressed, easy to rewrite on site
- Two parts construction with base mounted termination allows easy installation
- 16 programmable alarm tones
- Optional Evacuate + Alert mode
- Optional loop powered or external 24VDC powered
- Optional power saving mode or normal mode
- I-9403 has High intensity LED cluster
- I-9403 can program work in Light or Sound or Light plus Sound



C-94DB

Deep Base

Use with I-9403, I-9404, C-9403, C-9404 for Surface Cable Entry.



DI-9405/DI-9406

Addressable Sounder Base / Flashing Beacon Base

DI-9405/DI-9406 are base mount types, easily inserted between the detector and base without cabling, to produce a sound and light alert in case of receiving command from FACP, saving the cost of installation and wiring.

- Electronic addressed, easy to rewrite on site
- Sandwich structure for easy installation. No additional cable required
- Loop powered
- Three programmable modes, Share 1 address with detector or individual control in single-address / double-address mode
- 16 selectable tones
- Used with D series detectors and bases
- Bright red high-intensity, 1Hz frequency flash light (DI-9406 model)"



DI-9204E

Digital Manual Call Point

- Incorporates digital loop protocol, fast and reliable
- Re-settable (non-breaking glass) via special key
- Dual activation indicator
- Electronic addressed, easy to rewrite on site
- Plug-in structure, easy installation and maintenance
- Semi-flush mount type with a back box for surface mount



D-92WPB

Waterproof Box

- IP65 cover offers full protection of manual call point
- Meets the requirement of 2 step Operation
- Clear and durable PC cover
- Surface mounting enables the easy installation
- 60mm hole distance and enough internal space for most types of MCP
- Reserved location for additional micro-switch, battery, buzzer, etc



D-92FC

Flip Cover

- Material: PMMA
- Suitable with D series manual call point for double action
- Prevent from accident trigger
- Dimension: 87 X 92 X 20 (mm)
- Thickness: 1.7mm

EN54 Conventional Products

GST102A
GST104A

GST108A
GST116A



- Mains supply, 220/230VAC, 50/60Hz
- 2,4,8 or 16 zones, Each zone can have maximum 32 conventional detectors
- Compatible with GST conventional products
- Options to program supervisory zones, with individual supervisory indicator and supervisory relay output
- Provide fire, fault, aux. power, sounder output and disablement relay output
- Integrated charger and battery management program, fully complies with EN54-4 standard
- Easy operation to enable/disable zones, sounder outputs and alarm output
- Output programmable for interlink between zones and sounder outputs, alert or evacuate tone, with or without delay
- Alarm output and Fault output are available for integrating into third-party system
- Reserved repeater panel interface for fire alarm indication of multiple zones
- With AEOL solution to keep cable continuity even with detector removed
- Optional relay board to provide zone wise fire/fault relay output

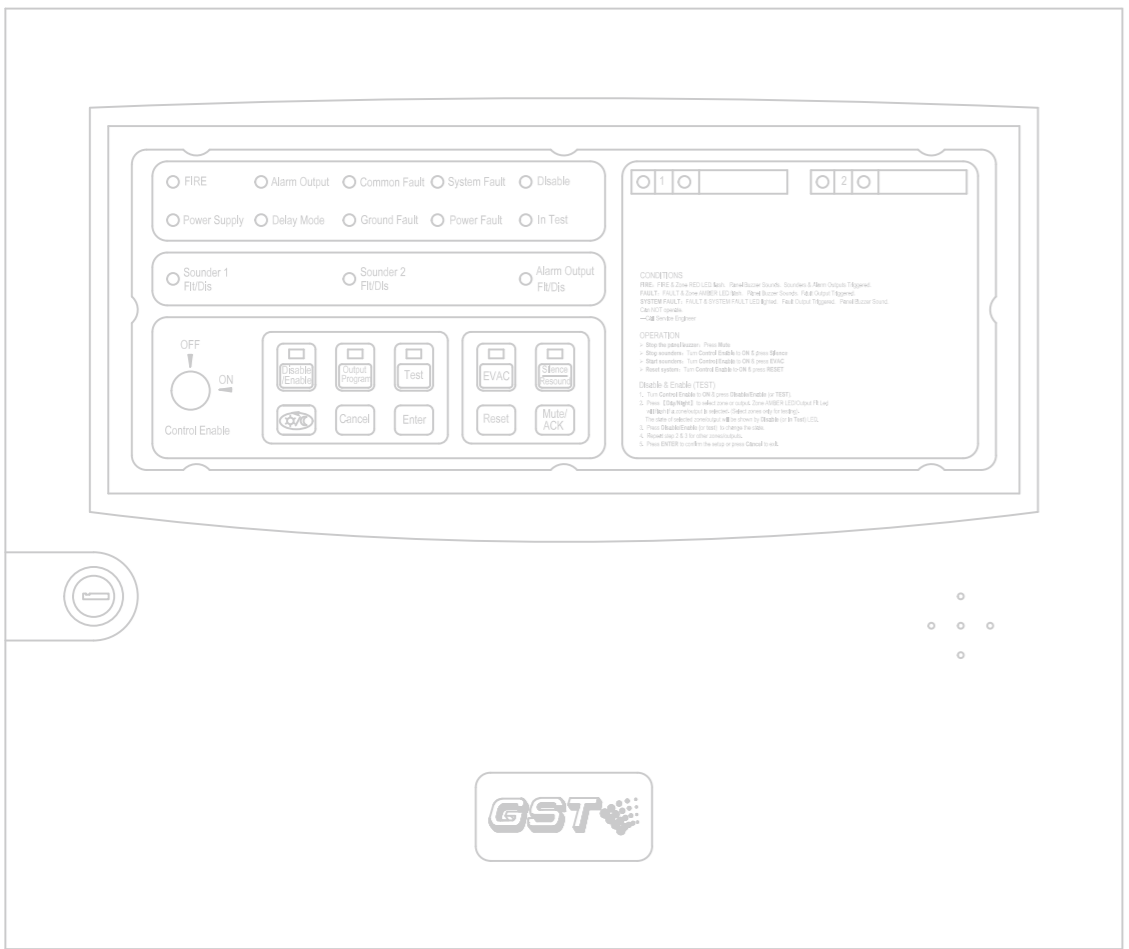

Relay Board for GST102/4/8/116A



GST101

1 Zone Conventional Fire Alarm Panel

- Mains supply, 220/230VAC, 50/60Hz
- Maximum 15 conventional detectors, non-limited manual call points
- Available sounder and fault output
- Indicate normal status, fault, alarm and check cables for short or broken circuit
- Integrated management program for charger and battery



GST-RP16

Conventional Repeater Panel

- Compatible with GST102A/4A/8A/16A
- Powered from FACP directly
- Provide Zonal Fire and general Fault indication
- Maximum 16 zones with fire signal
- Direct connecting, easy commissioning

DC-910XE Series Detectors

Have built-in microprocessor, are highly fixed with reliable fire judging program, ensuring stable and reliable performance, with the new designed smoke chamber and intelligent program, suitable for hotels, restaurants, office buildings, schools, banks, warehouses, libraries, computer rooms, switch rooms, etc.

- Strong environmental adaptability due to drift compensation
- Self-diagnostic
- Reed switch test
- Fire LED allows 360° viewing
- Possible to switch off polling LED avoid annoying
- A remote indicator C-9314P can be connected to each detector



DC-9101E DC-9101E-B

Conventional Combination Heat Photoelectric Smoke Detector

- Smoke and heat sensor are integrated in mechanism and circuitry structure
- 2 smoke sensitivity levels can be set
- Heat Detection: Class A2R



DC-9102E

Conventional Photoelectric Smoke Detector

- Light scattering technology with high performance chamber
- Suitable for detecting slow burning or smoldering fires
- 2 smoke sensitivity levels can be set



DC-9103E

Conventional Rate of Rise and Fixed Temperature Heat Detector

- Semiconductor heat sensor
- Dual Rate of Rise and Fixed Temperature
- 3 detection classes can be set A1R, A2S & BS



DB-01
DB-01-B

Common Detector Base

Associated with D series detectors
Color options: White and black



DB-01D

Diode Detector Base

DP-9907

Active End of Line

DP-9907 associated with DB-01D for Conventional System, to keep loop continuity while a detector is removed



C-9314P

Remote Indicator



DC-9105E

Conventional Reflective Beam Detector

Built-in microprocessor to reach high sensitivity application, suitable to historical buildings, warehouses, large storages, shopping malls, leisure centers, exhibition halls, hotel lobbies, printing houses, clothing factories, museums, and prisons.

- 24V powered
- Wide operating voltage range for monitoring large areas
- Built-in laser pointer and digital tube display facilitate the alignment between the detector and the reflector, and greatly improve the on-site commissioning efficiency.
- Built-in normally open fire relay and normally closed fault relay dry contact output
- Combination of the emitting and receiving part makes mounting easy and optical pathway accurate
- Intelligent self-adjustment, drift compensation of ambient data, such as dust accumulation, positional excursion, and ageing transmitter
- Intelligent fire alarm and fault auto-judgment
- Self-diagnostic function can monitor the internal fault
- 4 sensitivity levels can be set in field to suit different applications
- Ingress protection is up to IP66 through glue-seal treatment for special environment applications
- Attractive appearance



RF-9105R

Reflector Plate

C-94XX Series Sounder Strobes

Are notification devices, provide audible/visual warning signals to draw attention or evacuate in case of emergency.



C-9401N

Conventional Sounder Strobe

- 24VDC powered
- Red plexiglas lens, hi-light red, striking, long-life
- Sound level over 80dB
- Two-part plug-in structure for easy installation

C-9403/C-9404

Conventional Sounder Strobe/Sounder

- Two-part construction with base mounted termination allows for easy installation
- 2 selectable alarm tones
- Strobe provided by high intensity LED cluster

C-94DB

Deep Base

Use with I-9403, I-9404, C-9403, C-9404 for Surface Cable Entry



GST-JL

Alarm Bell

Suitable for factories, workshops, hotels etc. to provide clear and continuous alarm sound.

- 24VDC power, 23mA operation
- 6" bell, 95dB@3m



DC-9204E

Innovation Manual Call Point

- Non-addressable, alarms by pressing the glass
- Re-settable (non-breaking glass) via special key
- Dual activation indication
- Friendly installation and test
- Wiring before termination

Explosion Proof Products

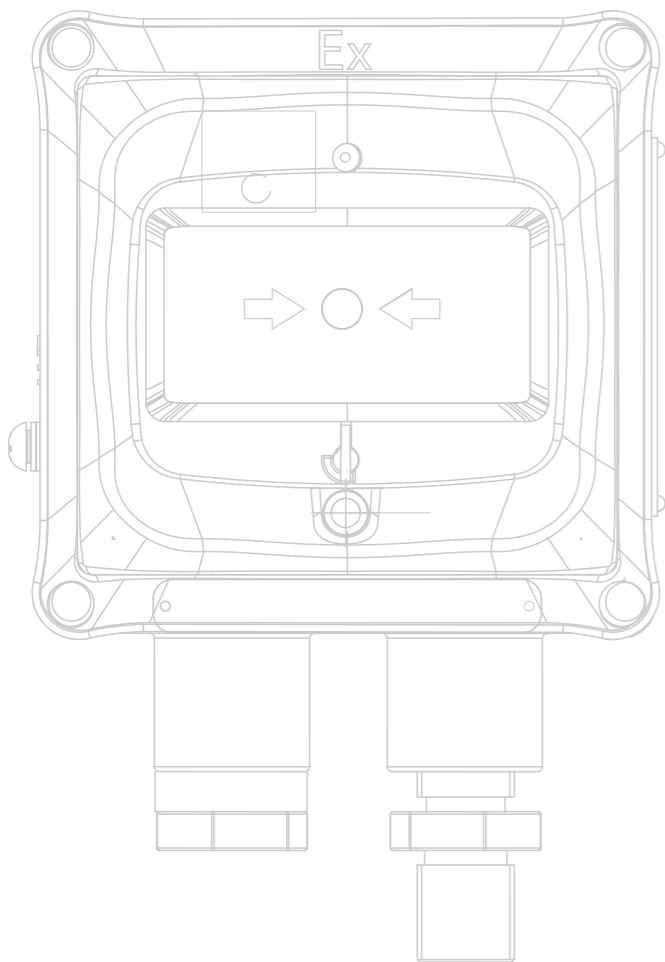

DI-9204Exd

Digital Flame-proof Manual Call Point

DI-9204Exd is applicable to vessels, Zone 1 and 2 of explosive gas atmosphere and explosive dust atmosphere. It is also suitable for outdoor applications.

- Work either in addressable or conventional mode
- Operating Voltage: 24V
- Ingress Protection: IP65
- Material: ZL102 aluminum alloy, red
- Dimension: 211mm x 129mm x 95mm
- Ex Mark: $\text{Ex II 2 G Ex db IIB T6 Gb, -40}^\circ\text{C} \leq \text{Ta} \leq +70^\circ\text{C}$
 $\text{Ex II 2 D Ex tb IIIC T80}^\circ\text{C Db}$
- ATEX Certificate: Presafe 14 ATEX 5549X



Ex

D-9105RExd

Digital Flame Proof Reflective Beam Detector

D-9105RExd is applicable to either commercial areas or hazardous industrial areas, such as Zone 1 and 2 of explosive gas areas and Zone 21 and 22 of combustible dust areas.

- Work either in addressable or conventional mode
- Operating Voltage: 24V
- Ingress Protection: IP66
- Material: Stainless steel, metallic gray
- Dimension: 344mm x 240mm x 212mm
- Ex Mark: Ex dIIC T6 Gb/Ex tD A21 IP66 T85°C
- Ex Certificate: CE16.1388X



Ex

DI-9104Exd

Digital Flame Proof UV Flame Detector



Ex

DI-9104Exd detects fire by picking up the ultraviolet light from flaming material. It's designed for areas where an open fire is liable to occur due to a large amount of radiation and no smoldering stage. This detector can be applicable to zone 1 and 2 of explosive areas.

- Work either in addressable or conventional mode
- Operating Voltage: 24V
- Ingress Protection: IP66
- Material: ZL102 aluminum alloy, silvery grey
- Dimension: 147mm x 106mm x 92mm
- Ex Mark: Ex d IIC T6 Gb
- ATEX Certificate: Presafe 14 ATEX 5547

D-9107RExd

Digital Flame Proof Dual IR Flame Detector



Ex

D-9107RExd uses two pyroelectric infrared sensors to detect the change of light signal of flame and background light signal at two bands of infrared spectrum through individual processing channels. The detector is applicable to explosive Zone 1 and 2, and flammable dust atmosphere.

- Work either in addressable or conventional mode
- Operating Voltage: 24V
- Ingress Protection: IP65
- Material: Stainless steel, metallic gray
- Dimension: 166mm x 235mm x 199mm
- Ex Mark: II 2 G Ex db IIC T6 Gb / II 2 D Ex tb IIIC T80°C Db
- ATEX Certificate: Presafe 14 ATEX 5548X



Ex



Ex



Ex



DC-910X(IS) Series Detectors

Are applicable to Zone 1 and Zone 2 of areas with explosion-proof requirements in petroleum and chemical industries.

With an explosion proof interface I-9332, the detectors can be connected into the GST addressable system. Max.10 pieces (mixed) can be linked to each interface.

- Strong environmental adaptability due to drift compensation
- Self-diagnostic
- Reed switch test
- Fire LED allows 360° viewing

DC-9101(IS)

Intrinsically Safe Combination Heat Photoelectric Smoke Detector

- 3 smoke sensitivity levels
- FT and RR
- Ex Mark: Exib II CT6 Gb
- Ex Certificate: CE21.0155

DC-9102(IS)

Intrinsically Safe Photoelectric Smoke Detector

- Integrated algorithm for high sensitivity
- Ex Mark: Exib II CT6 Gb
- Ex Certificate: CE21.2424

DC-9103(IS)

Intrinsically Safe Rate of Rise and Fixed Temperature Heat Detector

- BS and A1R
- Ex Mark: Exib II CT6 Gb
- Ex Certificate: CE22.3906

DB-01(IS)

Intrinsically Safe Detector Base

GST Intrinsically Safe Conventional Notification

Suitable to Zone 1 and Zone 2 of areas with explosion-proof requirements in petroleum and chemical industries. With Intrinsically Safe Interface, these conventional devices can be connected into the GST addressable system.



Ex

DC-9202(IS)

Intrinsically Safe Conventional Manual Call Point

Ex Mark: Exib II CT6 Gb
Ex Certificate: CE21.0157



Ex

DC-9403(IS)

Intrinsically Safe Conventional Sounder Strobe

Ex Mark: Exib II CT6 Gb
Ex Certificate: CE22.3905



Ex

DC-9404(IS)

Intrinsically Safe Conventional Sounder

Ex Mark: Exib II C T6 Gb
Ex Certificate: CE22.3907



I-9332

Intrinsically Safe Interface for Detectors/Manual Call Point

I-9333

Intrinsically Safe Interface for Sounder/ Strobe

The Intrinsically Safe Interface connects conventional intrinsically filed devices into the GST addressable fire alarm system, reporting the alarms with address or receiving the command from the panel to activate explosion-proof devices in the field. GST Intrinsically Safe Interface provides a cost effective and reliable application for the explosive area.

- Photoelectric isolation technology for output signal, the interface is safe to use and can restrict the interference of industrial frequency
- Electronic addressing, which can be modified in field
- Microprocessor monitors running status
- Built-in safety barrier, connecting with explosion-proof devices directly
- Cast aluminum alloy, silver grey IP65
- I-9332 reports the alarms with address to panels
- I-9333 receives the command from the panel to activate explosion-proof devices in field and limit the energy limitation to the hazard area



Ex

GST-AS-200

Zener Safety Barrier 1 line fused

GST-AS-300

Zener Safety Barrier 2 lines fused

Associates with intrinsically safe products to provide protection by limiting the energy into an explosive environment. It ensures the energy output always be controlled under a safe value in case of any kind of fault condition.

- Max. Output Voltage: $U_o=28V$
- Max. Output Current: $I_o=93mA$
- Ex Mark: [ExibGb] II C

Specified Detectors

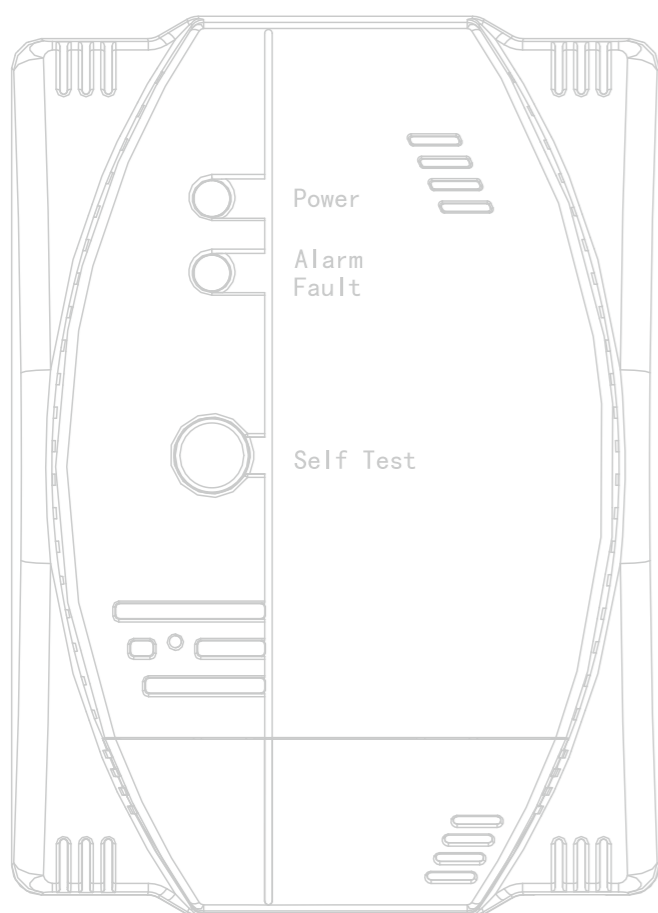

GST Gas Detectors

These devices have a built in MCU, high quality semiconductor gas sensor to achieve high sensitivity and reliability. When leakage of home use combustible gas (LPG, Natural Gas) is detected, detectors will generate a high buzzer alert sound, and provide a dry contact to turn the exhaust fan, a 12VDC source to switch off the gas valve. Very suitable to be used in houses, hotels and apartments.

I-9602LW-LPG I-9602LW-NG

Addressable Gas Detector
-Liquefied Petroleum Gas
-Natural Gas

- Operating Voltage: 24VDC
- Addressable: Compatible with GST FACP system
- Alarm Threshold: LPG: 2000×10^{-6} (10%LEL)
NG: 3000×10^{-6} (6%LEL)
- Ingress Protection: IP30



C-9602LW-LPG C-9602LW-NG

Standalone Gas Detector
-Liquefied Petroleum Gas
-Natural Gas

- Operating Voltage: 187VAC~253VAC
- Alarm Threshold: LPG: 2000×10^{-6} (10%LEL)
NG: 3000×10^{-6} (6%LEL)
- Ingress Protection: IP30



R6601 R6602

Conventional Smoke Detector Conventional Heat Detector

R660X series are 4-wire type detectors, usually applied to a security system, or standalone with relay output. Detectors provide a normally open contact, which will be closed when the detector alarms.

- Operating Voltage: 12VDC (9.6VDC~14.4VDC)
- Output Relay: 30VDC/1A
- Cabling Method: 4-wire, 2 for power, 2 for output
- Ingress Protection: IP23(R6601)
IP33(R6602)



S-9102R S-9102N

Stand Alone Smoke Detector

GST standalone smoke detector is battery powered with an adapting optical chamber to detect smoke produced by fire. The detector provides a high-volume sound notification in case of alarm and is suitable for small projects, such as home applications, small shops, pubs, etc.

S-9102R has a photoelectrical isolated polarized N/O contact output
S-9102N is networkable, suitable for group usage of detectors

- Operating Voltage: 2-AA LR6 alkaline batteries
- Battery Life: Around 3 years in normal operation
- Detection Area: 60-100m²
- Alarm Sound: >80dB@3m



Ultraviolet Flame Detector

Detects fire by analyzing ultraviolet radiation of flame. It's applicable to the places where open fire with intense flame radiation but without enough smoke happening, or where quick response to a fire is required.

I-9104

Intelligent Ultraviolet Flame Detector

- High sensitivity, reliable performance, dust-proof, damp-proof and corrosion-proof
- Three sensitivity levels
- Electronically addressed in field
- Built-in microprocessor stores 14 history data
- Auto-diagnostic



C-9104

Conventional Ultraviolet Flame Detector

- High sensitivity, reliable performance, dust-proof, damp-proof and corrosion-proof
- Auto-diagnostic



DZ-03

Common Detector Base

Gas Release Control Products

**Gas Extinguishing
DO NOT ENTER**



GST301

Conventional Gas Extinguishing Control Panel

The GST301 is a standalone gas extinguishing control panel, provides 2 conventional detection zones to achieve double knock control, and an additional standard fire detection zone for other areas. The Duty and Standby Cylinder control can be automatically- and manually-controlled controlled, with an adjustable delay timer

- Mains supply: 220/230VAC, 50/60Hz
- Backup Battery: 7AH/24VDC
- Sounder Output: 0.5A/24VDC
- Release Output: 2A/24VDC, Pulse
- Built-in PSU and charger for 24 hour standby and 30 minute activation period



GST303(3 zones)

GST306(6 zones)

Addressable Gas Extinguishing Control Panel

The gas panel sits directly on addressable loop, achieving extinguishing control by carrying out the intelligent equations on the fire panel.

- Mains supply: External Power Supply 24VDC
- Cylinder Output: Pulse (5s) or Continuous output, Max. 2A
- Release Indicator: 300mA/24VDC
- Sounder Output: Dry-contact, 1A/24VDC
- All cables monitored for fault of open circuit and short circuit
- Delay timer and release output period adjustable



Tools and Accessories



C-9317

Emergency Gas Override Control

C-9317 Emergency Gas Override Control is used to control the start and stop of gas extinguishing system, usually installed in areas to be protected. Self-latched buttons resettable by a special tool. A dedicated contact output for sending start signal. The start and stop buttons are protected by a glass cover to prevent from mis-operation.



C-9318

Gas Extinguishing Warning Indicator

C-9318 Gas Extinguishing Warning Indicator is the accessory of a gas extinguishing system, usually installed above the entrance of the protected area. Flashing Frequency: 1.4Hz 20%. Material and color: Iron enclosure/ white, with plexiglass in front/ white.



C-9329

Gas Extinguishing Control Relay Module

C-9329 Gas Extinguishing Control Relay Module is to use with GST303 or GST306 Gas Extinguishing Control Panel, to carry out gas release solenoid control and cable monitoring. Output contact: Rated 30VDC/ 2A. Plug-in structure for friendly application.

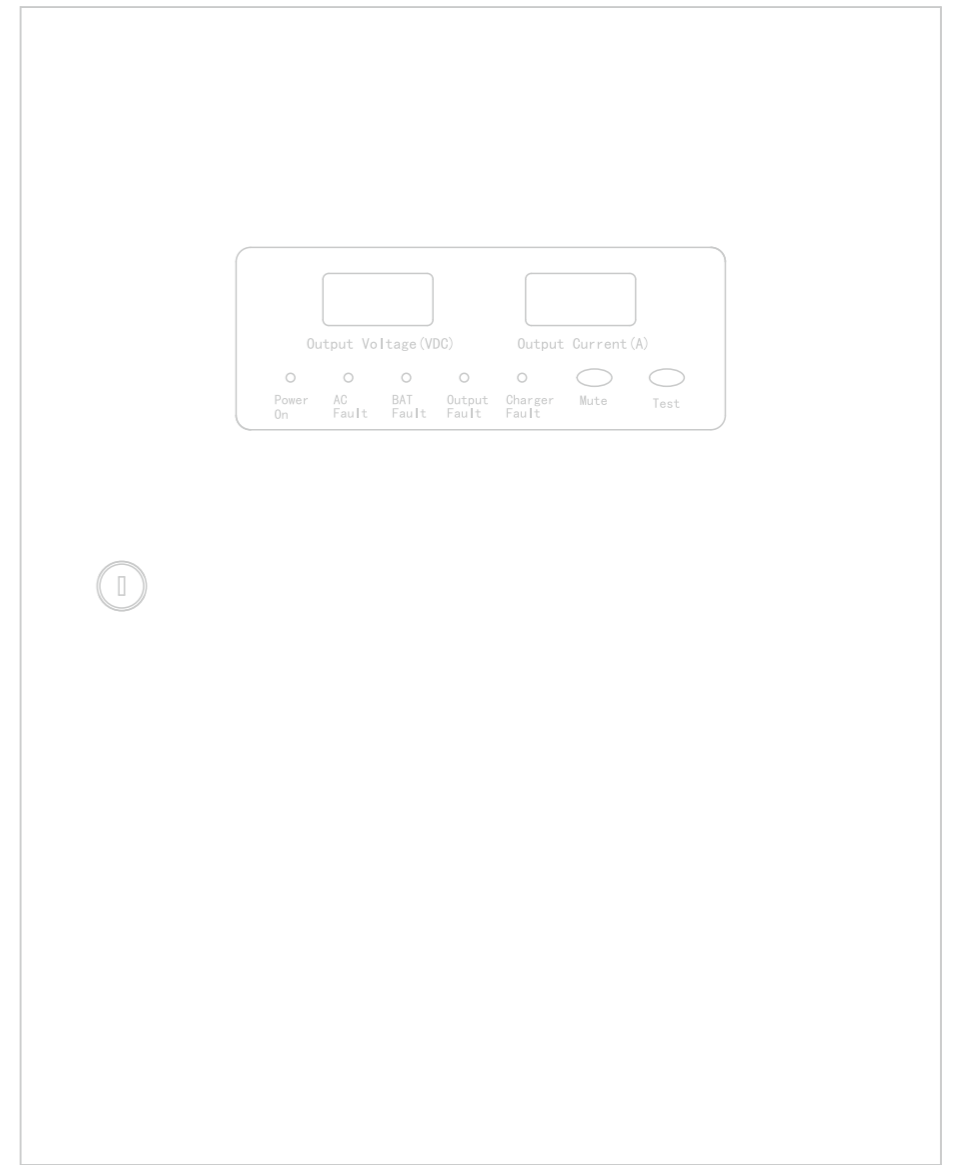

P-9910B

Handheld Programmer



A programming tool that can also be used to read the parameters and set the working mode of those devices.

- Handheld unit, portable tool
- Convenient operation
- Quadruple digit alphanumeric LCD display
- Low-consumption hibernation and power saving function
- Low battery indication

P-9903

Loop Relay Module



P-9903 expands loop distance, also provides strong protection for signals when the loop runs through heavy interference area.

- Enhance loop distance and reliability
- Increase 1000 meters of loop distance
- Maximum 2 pieces of relays can be connected in serial
- Opt-isolated output signal, resistant to industrial interference
- Output supports Class B loop connection only

CAN100H-4/8/12/16

CAN Hub



4/8/12/16 Routes

- Communication Distance: 3000 meters
- Node capacity of each branch: 112
- Total system capacity based on panel models
- Avoids loop interference of the whole system due to isolation between trunk and branch, branch and branch

CAN100F

Fiber Optic Converter

Convert CAN signal to Fiber Optic, expand communication distance up to 25km Transmission Medium:Single mode fiber



CAN100S

CAN Relay

Extends CAN network distance an additional 3000 meters and node capacity to 112



GST Intelligent Power Supply Unit (PSU)

GST PSU is designed to support heavy consumption applications, for the fire alarm devices requiring external 24VDC power supply. The built-in charger and maintenance-free sealed lead acid batteries ensure the standby supply.

PSU24-5 PSU24-5A (Networkable)



- Mains Supply: 230VAC+10%/-15%, 50/60Hz
- Rated Output: 5A/26.5V DC
- Backup Battery: 12Ah/24VDC
- Dimension: 400mm×318mm×128mm
- PSU24-5A networkable, report fault of mains loose, battery loose or output broken to the fire panel

PSU24-10 PSU24-10A (Networkable)



- Mains Supply: 110VAC~230VAC, 50/60Hz
- Rated Output: 10A/26.5V DC
- Backup Battery: 24Ah/24VDC
- Dimension: 520mm×350mm×156mm
- PSU24-10A networkable, report fault of mains loose, battery loose or output broken to the fire panel

Software

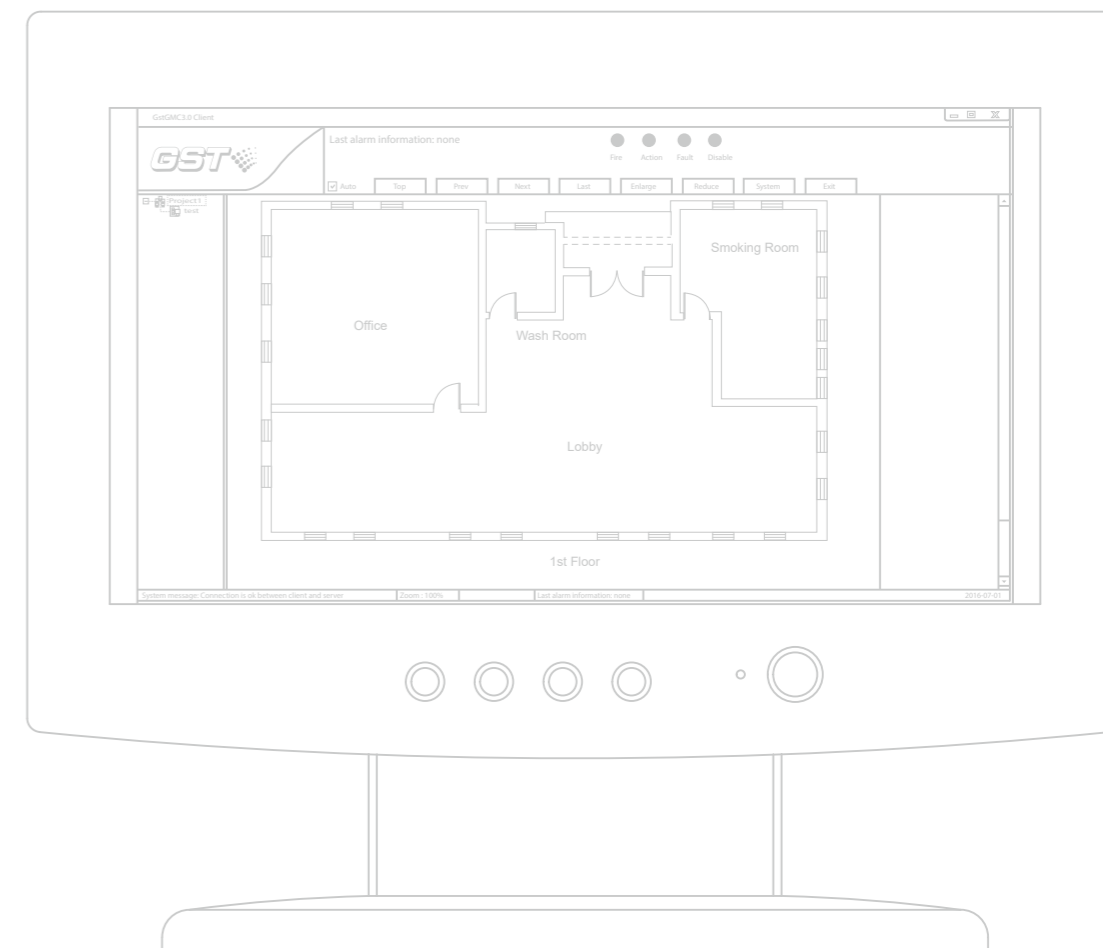

GST Graphic Monitor Center

Fire alarm system monitoring software, designed by GST, to show the system diagram at a computer screen. Equipped with a friendly interface to achieve remote monitoring and control.

Hardware Requirement

CPU: Pentium III 1G or above minimum free
Hard disk: 10GB Memory: 2GB or above

Operation System

Windows 7, Windows 10 (IE8.0 or above)
GST-GMC also can be operated in Windows XP Professional (IE6.0 or above)



GstGMC-M2.2 GstGMC3.0

- Supports 8 remote client stations plus local monitor station
- With OLE for Process Control (OPC), can be integrated into other systems
- Licensed with password
- GstGMC-M2.2 can be used with GSTM200 panels
- GstGMC3.0 can be used with GST200N and GST-IFP8 series panels

GST-IFPX-GMC-S/M/L



- New generation with creative technology, used with GST IFPX series
- Displays creatively with device icons and text window, to realize perfect explicitness.
- Supporting maximum 10 client stations
- Satisfy different projects from less than 500, between 500-2000 and more than 2000 addresses
- Licensed by a dongle key, safe even if the computer collapses

DEF-KEY DEF-KEY-TIMER



USB Dongle Key

DEF-KEY is a security device. With a CPU or smart card, it will protect a definition database configured with GST Def software and panel project configuration data from the unauthorized approach. The person without the right Dongle Key is not permitted to enter the Def software or create communication between the Def software and panels.

DEF-KEY can protect the system from a dangerous change and maintain the safe operation from authorized configuration

DEF-KEY-TIMER is an advanced model, which allows customized validity and renewal.

System Diagram



EN Product System Diagram

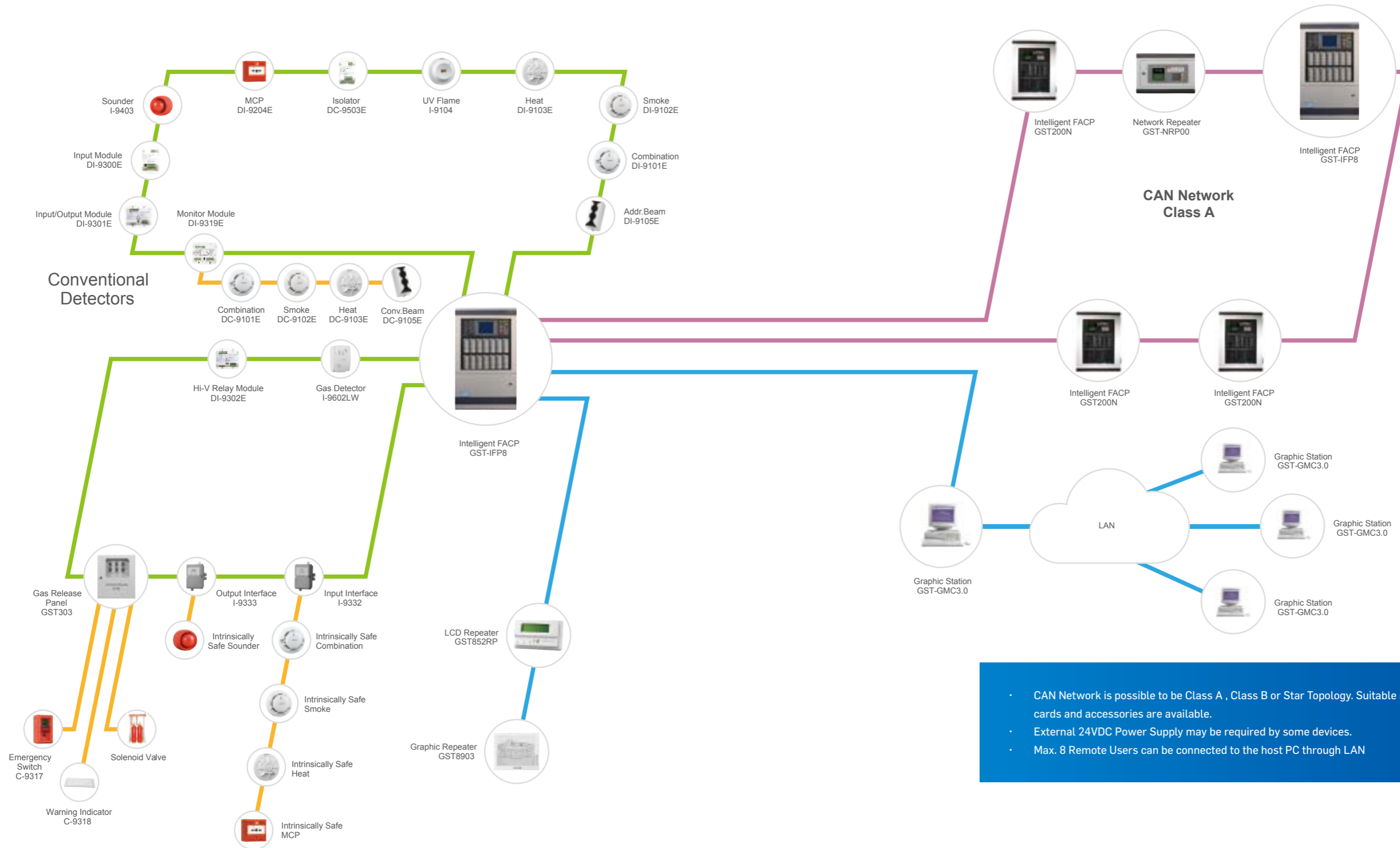

- CAN Network is possible to be Class A , Class B or Star Topology. Suitable network cards and accessories are available.
- External 24VDC Power Supply may be required by some devices.
- Max. 8 Remote Users can be connected to the host PC through LAN

UL Listed Product System Diagram

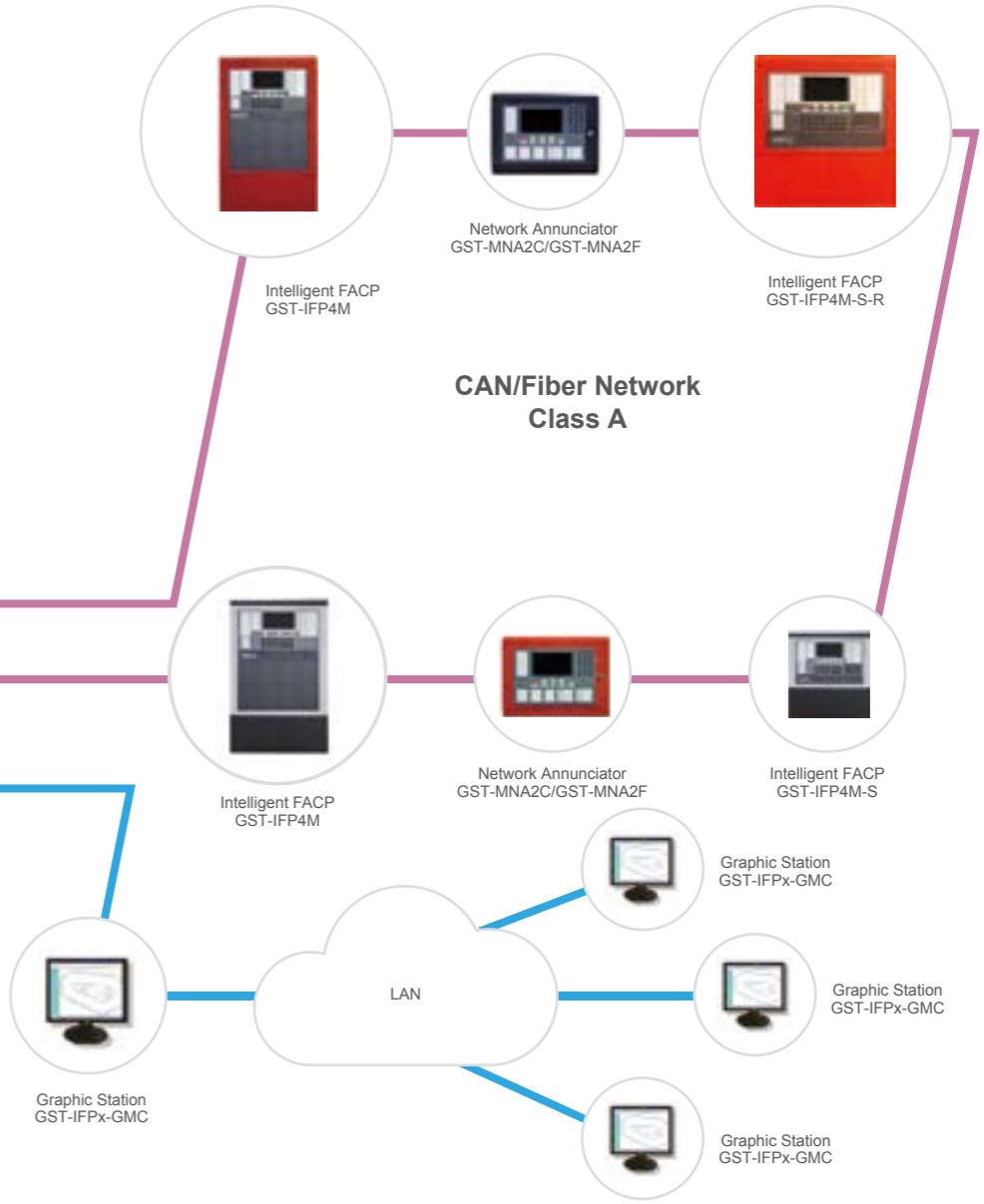

- Need additional CAN/Fiber network card to be installed into panel for networking
- Maximum 10 Remote Users can be connected to the host PC through LAN
- Maximum output of Panel NAC+ Auxiliary output is 2.5A

Emergency Voice Evacuation

GST Fire Telephone panels

Specialized for emergency communication. Call from handset will be transferred to networked fire telephone panels automatically after not answered by the dedicated panel.



GST-FT8WN

Fire Telephone Panel
8 Zone/Wall-Mount

GST-FT24N

Fire Telephone Panel
24 Zone/19" Rack-mount

- Mains supply: 24VDC
- Conventional model
- Networkable up to 8 panels
- Each zone fully monitored of cable fault
- One zone failure won't affect other zones
- Network communication monitored

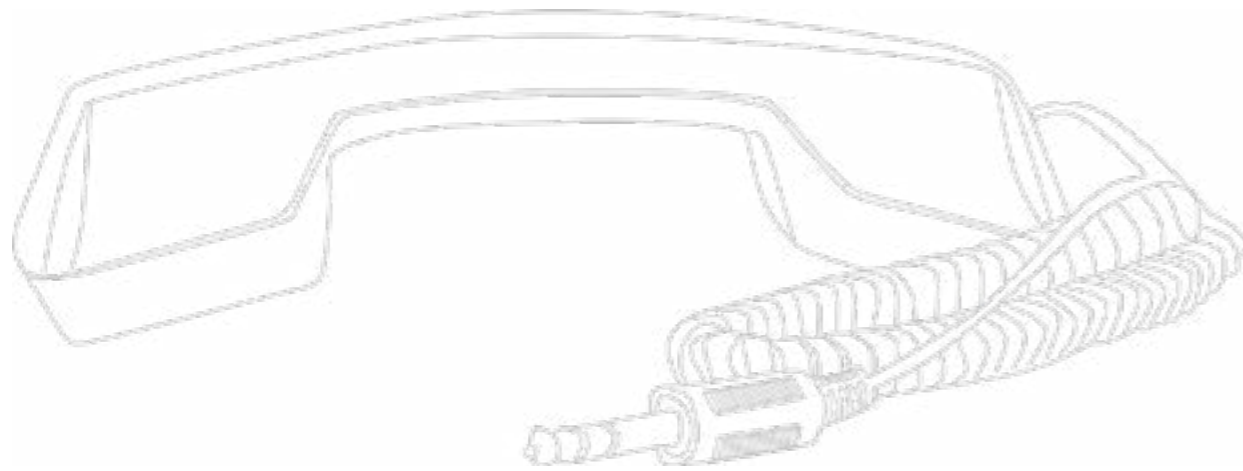

P-9911(H)

Hands-free Speaker Fire Telephone



P-9911(F)

Fixed Fire Telephone Handset



P-9911(M)

Mobile Fire Telephone Handset



P-9911(J)

Fire Telephone Jack

Emergency Voice Evacuation System

GST-VES voice evacuation allows for emergency voice announcements to evacuate people inside a building. With microphone, amplifier, and speakers, the system will release an alarm tone first, allowing the building manager or fire supervisor to broadcast the tone through a microphone. GST Voice Evacuation System equipment meets National Fire Protection Association (NFPA) standard and is UL approved.



Features

- True Multiplex 6 Channel Audio
- Integrated Fire Phone
- Integrated 2 Channel Digital Message Repeater
- Live Microphone Page to any zone
- Fast RS-485 Communication Protocol
- Fully Supervised
- Easy Installation and Operation
- Natural Sound Voice Recordings
- Built-in Alarm and Alert Signals
- Up to 4 Minute Message Capacity
- Integrates with GST Fire Alarm Panel by RS232 or dry contact
- Interfaces with non GST Addressable and Microprocessor-based Fire Alarm Panels
- 2 Minute Message Restart on Microphone Key

GST-MP

Master Panel

GST-MP is the Master Panel of the GST voice evacuation system. It provides the programming and operating interface, operates in conjunction with the Fire Alarm Control Panel (FACP) in a building to provide an automatic response to life safety emergencies

GST provides two basic master panel models with the option to be integrated into the Fire Alarm Control Panel.
GST-MP16 : 16 switches/LEDs and 16 inputs for FACP with Cabinet

GST-MP16x: GST-MP16 without Cabinet, for integrating into GST-IFP8-VT



GST-DP

Distributor Panel

GST-DP is the Distributed Panels in the system. All GST-DP are connected to a master panel, receiving the command and voice signal from GST-MP, amplifying, and providing 25V or 70V audio source to the speaker directly.

GST provides 4 basic option of GST-DP

GST-DPS50, single channel, 50W

GST-DP50, dual channel, 50W

GST-DPS100, single channel, 100W

GST-DP100, dual channel, 100W



Emergency Voice Evacuation System



MFP

Master Fire Phone Card

Accessory on master panel for fire phone. Add 1 MFP to GST-MP16 or GST-MP16X if the fire phone is required.



GST-MFH-A

Master Fire Phone Handset Assembly

Accessory on master panel for fire phone. Add 1 MFH to GST-MP16 or GST-MP16X if the fire phone is required.



SLC

Switch LED Card

Accessory on master panel. One SLC card provides 16 switches and LED's for manual control at Master Panel. Add SLC cards if more than 16 switch/LED are required



SSC

Switch Scan Card

Accessory on master panel. Each SSC card controls up to 8 switch/LED cards. One SSC card is included in the basic GST-MT master panel.



GST-XI

Extended Input Interface card

Accessory on master panel. One XI card provides 16 additional inputs to master panel. Maximum 7 XI can be connected to one II card.



MBK

Mother Board Relays

One MBK card provides 4 class "B" speaker circuits. And two MBK cards provide 8 "class B" or 4 "class A" speaker circuits in one distributed panel. One MBK card is included in basic GST-DP panel.



GVX-BA

Backup Amplifier Switching Relay

One required for each Distributed Amp when automatic switching / redundant amplification is needed. On a Single Channel system the backup amplifier can be located in any GST- DP panel. On a Dual Channel system an additional AMI card, and EVX needed. #E Amplifier assembly is required (the # represents the largest power amplifier in the system 50/100).



FPO2

Fire Phone Interface Terminal

One FPO2 provides 4 additional terminals for fire phone circuits. It is required for the 2nd, 3rd and 4th FPI Fire Phone Interface in GST-DP.



FPI

Fire Phone Interface

Each FPI provides 4 supervised class "B" fire phone circuits in a DP panel. Maximum 2 FPI (8 phone circuits) can be installed in one GST-DP.



GVX-50E / GVX-100E

Amplifier Module

GVX-50E is a 50W amplifier module and GVX-100E is a 100W amplifier module. The amplifier module is included in basic GST-DP. Amplifier modules may be ordered as spare or adding extra output power to GST-DP. Max 2 amplifier modules can be mounted in one GST-DP.



XFMR

Transformer

This transformer is for amplifier module. 220VAC, 50Hz. It is required if additional amplifier is added to GST-DP.



P-9935EVAX

Communication Card

This card provides interface between GST-IFP8-VT FACP and GST-MP via RS232 port. It is not required if the dry contact interface is employed.

Emergency Voice Evacuation System

Part No.	Product Description	Default QTY	Max. QTY	Max. QTY
GST-MP16	Master panel, with 16 inputs, 16 Switches/EDs, with Cabinet	N/A	N/A	N/A
GST-MP16x	Master panel, with 16 inputs, 16 Switches/EDs, without Cabinet	N/A	N/A	N/A
GST-DP50	Distributed panel, Dual channels 50 Watts, 4 Class B speaker circuits	N/A	N/A	N/A
GST-DPS50	Distributed panel, Single channel 50 Watts, 4 Class B speaker circuits	N/A	N/A	N/A
GST-DP100	Distributed panel, Dual channels 100 Watts, 4 Class B speaker circuits	N/A	N/A	N/A
GST-DPS100	Distributed panel, Single channel 100 Watts, 4 Class B speaker circuits	N/A	N/A	N/A
SLC	Switch LED Card	1 ⁽¹⁾⁽²⁾	64	Optional components for Master Panel, More than 16 switches and LED's required, another SLC is needed
SSC	Switch Scan Card	1 ⁽¹⁾⁽²⁾	8	Optional components for Master Panel, Every 8 SLC needs one SSC
MFP	Master Fire Phone Card	0	1	Optional components for MP
GST-MFH-A	Master Fire Phone Handset Assembly	0	1	Optional components for MP
FPI	Fire Phone Interface	0	4	Optional components for Distributed Panel, 4 supervised Class "B" Fire Phone circuits per FPI
FPO2	Fire Phone Output Adapter	0	3	Optional components for Distributed Panel, More than 1 FPI is required in a Distributed Panel, one FPO2 card is needed for each
GVX-50E	Amplifier Module	1 ⁽⁴⁾ 2 ⁽³⁾	1 ⁽⁴⁾ 2 ⁽³⁾	Optional components for GST-DPS50, if converts from GST-DPS50 to GST-DP50, one GVX-50E is needed
GVX-100E	Amplifier Module	1 ⁽⁶⁾ 2 ⁽⁵⁾	1 ⁽⁶⁾ 2 ⁽⁵⁾	Optional components for GST-DPS100, if converts from GST-DPS100 to GST-DP100, one GVX-100E is needed
MBK	Mother Board Relays	1 ⁽³⁾⁽⁴⁾⁽⁵⁾⁽⁶⁾	2	Optional components for Distributed Panel, One additional MBK needed for 8 Class "B" or 4 Class "A" Speaker Circuits on Distributed Panel.
P-9935EVAX	RS232 Communication Card	0	1	Interface card between GST-IFP8 or GST-IFP8-VT and Master panel, Provides communication between GST-IFP8 panel and GST-MP
XFMR	Transformer	1 ⁽⁴⁾⁽⁶⁾ 2 ⁽³⁾⁽⁵⁾	1 ⁽⁴⁾⁽⁶⁾ 2 ⁽³⁾⁽⁵⁾	Optional components to convert single channel Distributed panel to dual channels Distributed panel. One transformer required per amplifier
XI	Extended Input Interface	0	7	Optional components for Master panel, connect, connect with II Input Interface card, provides additional 16 inputs per XI card

- (1) Configuration for GST-MP16
- (2) Configuration for GST-MP16x
- (3) Configuration for GST-DP50

- (4) Configuration for GST-DPS50
- (5) Configuration for GST-DP100
- (6) Configuration for GST-DPS100

Technical Specification

- Communications: RS-485 Standard, 1M Baud rate
- Primary Supply: 220VAC
- Backup Battery: 7AH/24VDC(GST-MP), 17AH/24VDC(GST-DP)
- Electrical Ratings: All Circuits @ 24VDC
- End of Line Resistor: 10k
- Maximum Cable Length: 4,000 feet, #16 AWG, between panels, 50,000 feet in the overall system
- Recommended Cable: 16 or 18 AWG, (Low-Capacitance) UTP Unshielded-Twisted Pair

GST-VES system diagram

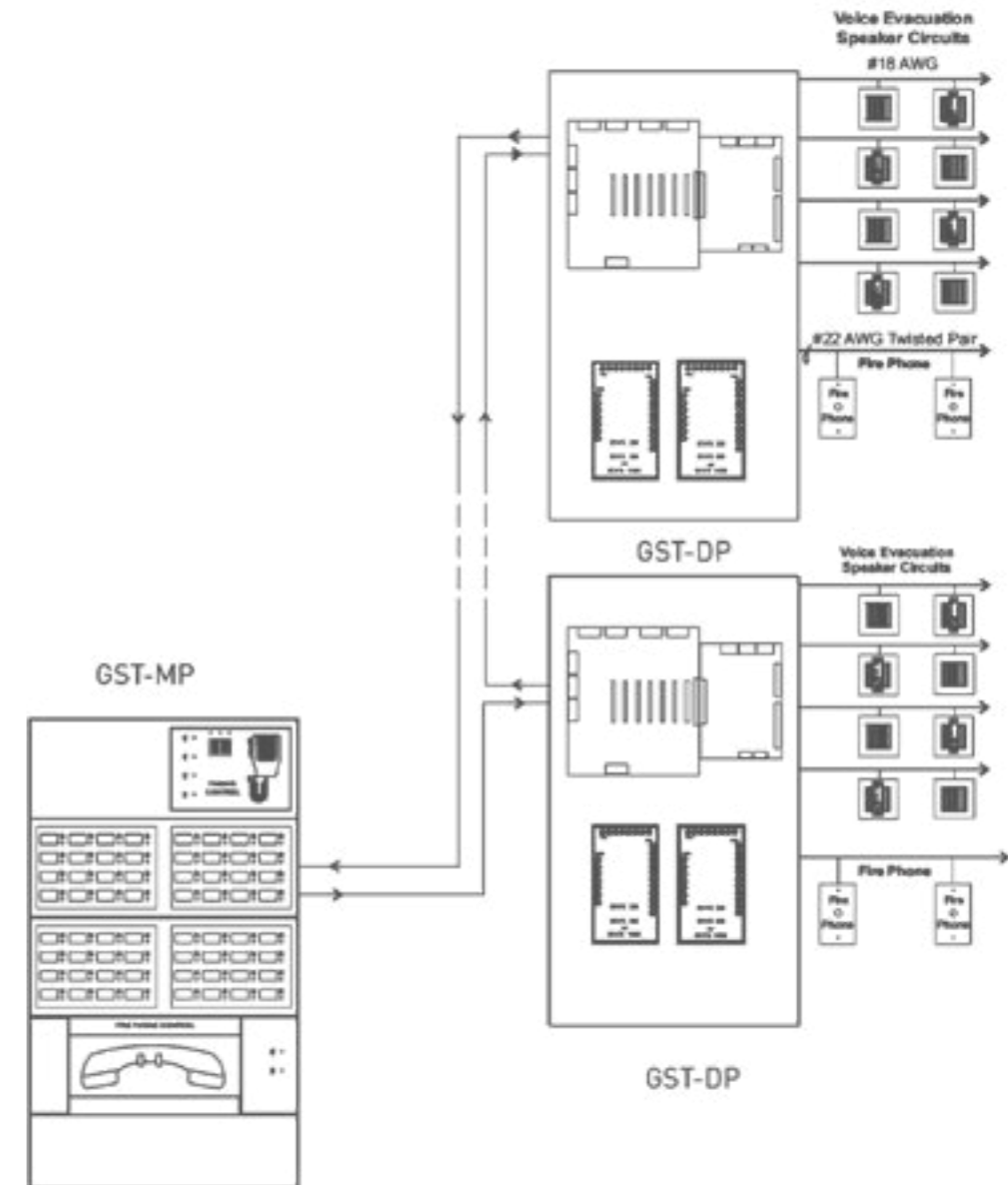

System Diagram - GST-VES with GST-IFP8-VT

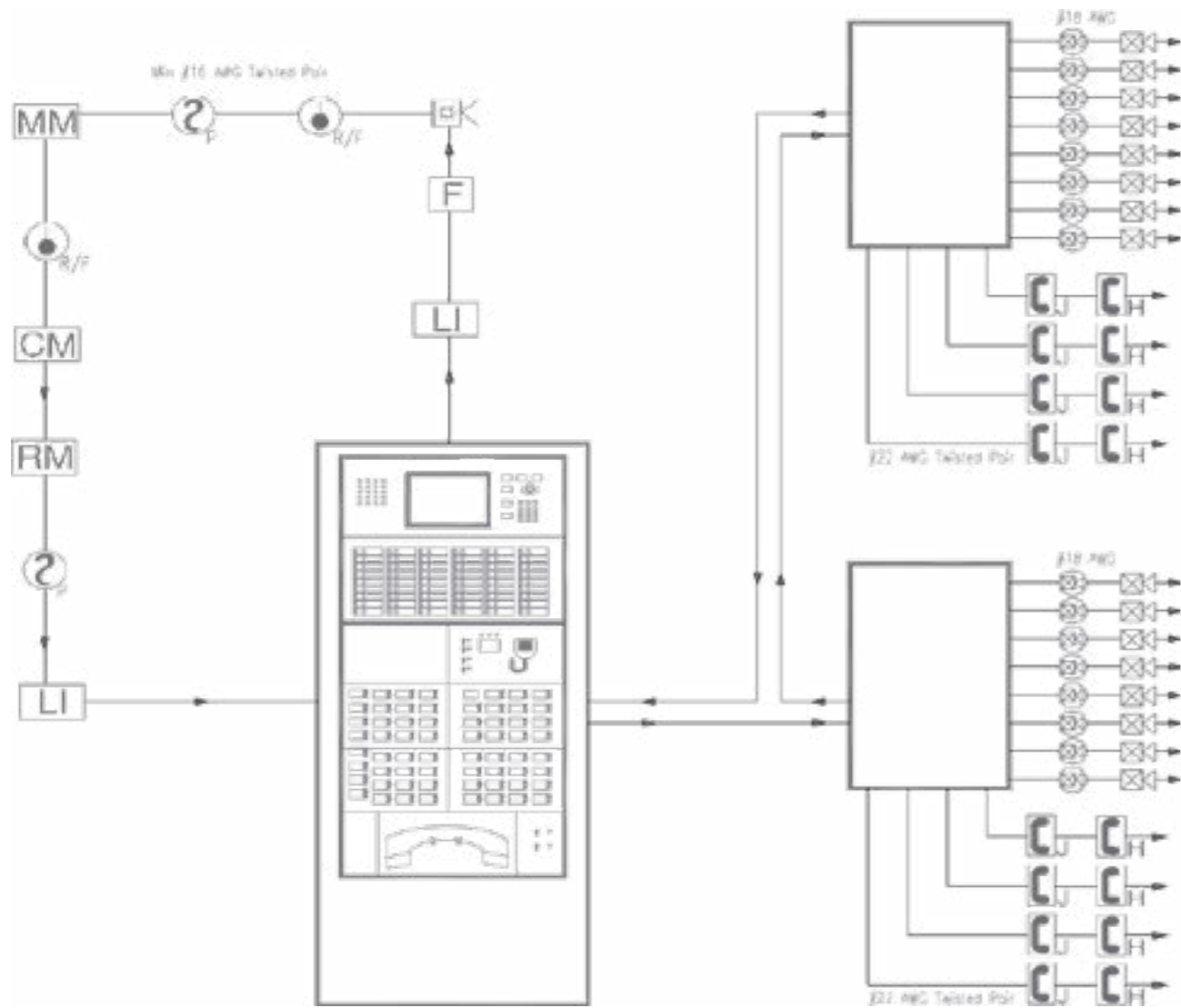

IMPORTANT: This publication is a generic version in which product information is shown for informational purposes only and does not constitute a specific commitment or guarantee. We are constantly pursuing the improvement of product technology to improve product performance, for which we reserve the right to adjust the configuration and technical information of the related products without notice. In addition, the description of system performance in this publication applies only to the usual situation. As a result, there may be a variety of unpredictable special circumstances in the real world, so the realization of the relevant product performance will depend on the professional investigation and analysis and the design plan. Please contact us and we will be happy to provide you with professional advice.

EMEA Headquarters

Carrier Fire & Security EMEA BVBA
(Europe, Middle East & Africa)
Pegasus Park - De Kleetlaan 3 1831
Diegem · Brussels, Belgium
Tel: +32 (0)2 725 1120
Fax: +32 (0)2 721 4047
E-mail: emea@carrier.com

South East Asia

Carrier Fire & Security Singapore Pte Ltd
Add: 28 Teban Gardens Crescent, Singapore 608926
Tel: (65) 6506 1616
Fax: (65) 6298 7310
Email: Tuan.Truong@carrier.com

Taiwan, China

Carrier Fire & Security Ltd., Taiwan
Add: 15F., No.156, Sec. 1, Zhongshan Rd., Banqiao Dist.,
New Taipei City 220, Taiwan
Tel: +886 2 8964 3777 ext. 3236
E-mail: hsuan.liu@carrier.com

MEA

Carrier Fire & Security Products
Add: PO Box 30791 Palladium Building 203 & 209 Dubai,
United Arab Emirates
Tel. +971 4 4199000
E-mail: marketingme@carrier.com

India

Carrier Technologies India Ltd.
Add: Bren Optimus, No 8/2, 3rd floor, Dr M H Marigowda Road,
Adugodi, Bangalore -560029, India
Tel: +91-080-43442000
E-mail: central.communications@carrier.com

Gulf Security Technology Co.,Ltd Carrier Global Corporation (Carrier)

12F, Building A, New Bund World Trade Center (I), No.4, Lane 255,
Dong Yu Rd, Shanghai 200126, China

ASIA: Tel: +86 21 38938223 Email: asiasales.gst@carrier.com

EMEA: Tel: +86 21 38938219 Email: emeasales.gst@carrier.com

LA & ANZ: Tel: +86 21 38938217 Email: lasales.gst@carrier.com

China's Contracted Projects Overseas (Chinese spoken only) :

Tel: +86 10 65540785 Email: overseasales.gst@carrier.com

www.gst.com.cn www.corporate.carrier.com